

Crystal Clear Technology

Product Specification

T430A21X00X

(REVISION 3)

Customers are requested to read through and understand this product specification. If no feedback is received from customer by 30 days, it is deemed that customer has fully need, understand and agreed on the specification set forth in this document.

Acknowledged by,

Date: _____

(CUSTOMER'S SIGNATURE)

REMARK: AFTER THE ACKNOWLEDGEMENT HAS BEEN SIGNED, PLEASE RETURN TO CCT.

Crystal Clear Technology sdn. bhd.

16 Jalan TP5, Taman Perindustrian Sime UEP,
47600 Subang Jaya, Selangor DE
Malaysia.

T: +603 80247099

Website: www.cct.com.my



2. Record of Revision

Rev	Date	Item	Page	Comment	Prepared	Checked
1.0	06.08.19			Initial Release	SCChong	W.Hong
2.0	29.06.20	3 8	5 23	Remove Note (7) Remove 8.1 -Widen the opr & stg temperature for RTP	SCChong	W.Hong
3.0	07.07.20	3 4.2 4.3 6.2 6.3 6.4	5 7 8 18 18 19	Change the CTP IC from FT5316 to F5446 Update the current IDD Update Half Life Expectancy to 50K Change the Vcc min to 2.7V Change the IC from FT5316 to FT5446 Update the I2C timing characteristics	SCChong	W.Hong



3. General Specification

T430A21X00X is 4.3" color TFT-LCD (Thin Film Transistor Liquid Crystal Display) module composed of LCD panel, driver ICs control circuit, LED backlight with or without TP (Touch Panel). This display area contains 480(RGB) x 272 pixels and can display up to 16.7M colors. This product compliant with RoHS environmental requirement.

Item	Specifications	Unit	Note	
Size (Diagonal)	4.3	inch		
Outline dimensions	105.50(W) x 67.20(H) x 2.90(T)	mm	(1)	
TFT	Display type	16.7M color TFT, Normally Black	(2)	
	Viewing direction	ALL	O'clock	
	TFT Active area	95.04(W) x 53.86(H)	mm	
	TFT Resolution	480(RGB) x 272	-	
	Pixel size	0.198(W) x 0.198(H)	mm	
	Pixel arrangement	RGB vertical strip	-	
	TFT Driving IC	SC7283 or Equivalent	-	
	TFT Interface mode	RGB	-	
	Luminance	500 (min)	cd/m2	(3)
RTP	RTP Outline Dimension	104.70 (W) x 64.90(H)	mm	
	RTP Viewing Area	99.70 (W) x 58.60 (H)	mm	
	RTP Active Area	96.70 (W) x 53.90 (H)	mm	
	RTP Top Circuit	ITO FILM	-	(4)
	RTP Bottom Circuit	ITO GLASS	-	(5)
	RTP Optical Characteristics	Transparency >78%	-	
	RTP Operation Force	50 - 120g	-	
	RTP Linearity	≤ 1.5%	-	
	RTP Thickness	1.2	mm	



	Item	Specifications	Unit	Note
CTP	CTP Outline Dimension	120.38(W) x 79.20(H)	mm	
	CTP Active area	95.04(W) x 53.86(H)	mm	
	CTP Resolution	480 x 272	-	
	CTP Origin	Top-left (FPC down)	-	
	CTP Controller	FT5446	-	
	CTP Interface mode	I2C	-	
	Touch mode	5 fingers multi touch	-	
	Cover lens material	Glass	-	
	Transparency	85	%	
	Operating temperature	-20 ~ +70	°C	(6)
Storage temperature	-30 ~ +80	°C	(6)	

Note:

- (1) FPC or Wire or Foam Tape or RTP or CTP are not included.
- (2) Color tone is slightly changed by temperature and driving voltage.
- (3) Brightness on LCD surface. Module with CTP or RTP, brightness will be about 20% (max) lower on the touch panel surface.
- (4) Anti-glare Hard-coating: Thickness:0.188mm
- (5) Thickness:0.7mm
- (6) This product specification shows range of value either in the minimum, typical or maximum category. Operating under extreme condition, bordering on the minimum or maximum range, does not mean that the product can survive perpetually under these extremities. In fact, it only means that the product can operate under such condition with no information of lifetime, other than those already indicated in the specification. User is advised to test it on their own if the specification's reliability data did not indicate it



STANDARD TFT MODULE ORDER INFORMATION (TABLE)

	T											
<u>MODEL NUMBER</u>	_____				_____	_____		_____	_____		_____	
<u>DISPLAY SIZE (DIAGONAL) in inch</u>	_____				_____	_____		_____	_____		_____	
<u>VIEWING ANGLE</u>	_____				_____	_____		_____	_____		_____	
T : Top view (12 O'clock)												
B : Bottom view (6 O'clock)												
W : Wide viewing angle (O-Film)												
A : All Direction												
<u>MODULE VERSION</u>	_____				_____	_____		_____	_____		_____	
<u>SERIES NUMBER FOR THIS STANDARD SPECIFICATION</u>	_____											
<u>TOUCH PANEL OPTION</u>	_____											
N : Without Touch Panel												
C : Capacitive Touch Panel												
R : Resistive Touch Panel												
<u>SEMI - CUSTOMISE (MINOR CHANGES FROM STANDARD MODEL)</u>	_____											
00 - STANDARD SPECIFICATION MODEL												
REFER TO FACTORY FOR OTHER VERSIONS. TERMS AND CONDITIONS APPLY												
<u>COVER LENS OPTION</u>	_____											
C : Cover Lens												
<u>OTHER OPTION (if any)</u>	_____											
H : with HDMI board												



4. AC/DC Characteristics (TFT)

4.1 Absolute Maximum Ratings ($V_{SS} = 0V$, $T_a = 25^{\circ}C$)

Item	Symbol	Min	Typ	Max	Unit	Note
Power Supply Voltage	VDD	-0.3	-	+4.0	V	
Backlight Forward Current	I _f	-	-	60	mA	
Storage Humidity	HST	10	-	90	%RH	(1)
Storage Temperature	TST	-30	-	+80	°C	
Operating Humidity	HOP	10	-	90	%RH	(1)
Operating Temperature	TOP	-20	-	+70	°C	

Note:

- (1) At $25 \pm 5^{\circ}C$. Absolute humidity shall be less than 90%RH at $+60^{\circ}C$.
- (2) Stresses above those listed under "Absolute Maximum Ratings" may cause permanent damage to the device. These are stress ratings only. Functional operation of this device at these or any other conditions above those indicated in the operational sections of this specification is not implied and exposure to absolute maximum rating conditions for extended periods may affect device reliability.

4.2 Electrical Characteristics ($V_{SS} = 0V$, $V_{DD} = 3.3V$, $T_a = 25^{\circ}C$)

Item	Symbol	Min	Typ	Max	Unit	Note
Power Supply Voltage	VDD	3.0	3.3	3.6	V	
Operation Current	I _{DD}	19	25	30	mA	
Low Level Input Voltage	V _{IL}	V _{SS}	-	0.3V _{DD}	V	
High Level Input Voltage	V _{IH}	0.7V _{DD}	-	V _{DD}	V	
Low Level Output Voltage	V _{OL}	V _{SS}	-	V _{DD} +0.4	V	
High Level Output Voltage	V _{OH}	V _{DD} -0.4	-	V _{DD}	V	

Note:

- (1) The recommended operating conditions refer to a range in which operation of this product is guaranteed. Accordingly, please make sure that the module is used within this range. And these current values are measured under the condition that all devices are stopped, each component is stable and logic signal is input.



4.3 LED Backlight Specification (Ta = 25°C)

Item	Symbol	Condition	Min	Typ	Max	Unit
LED Supply Voltage	Vf	If = 40mA	14.0	15.0	17.0	V
LED Supply Current	If		-	40	-	mA
Luminous Intensity	Lv	White	500	650	800	cd/m ²
Half Life Expectancy	LL	If = 20mA/LED	-	50000	-	hrs
LED Configuration	10 White LED, 5 in Series, 2 in Parallel					

Note:

- (1) The LED Supply Voltage is defined by the number of LED at Ta = 25°C and If = 40mA.
- (2) The “Half Life Expectancy” is defined as the module brightness decrease to 50% of original brightness at Ta = 25°C and If = 20mA/LED. The LED lifetime can decrease if the operating If is higher than 20mA/LED.
- (3) Brightness measurement done at LCD surface.



4.4 Timing Characteristics (VSS = 0V, VDD = 3.3V, Ta = 25°C)

4.4.1 System Bus Timing for RGB Interface

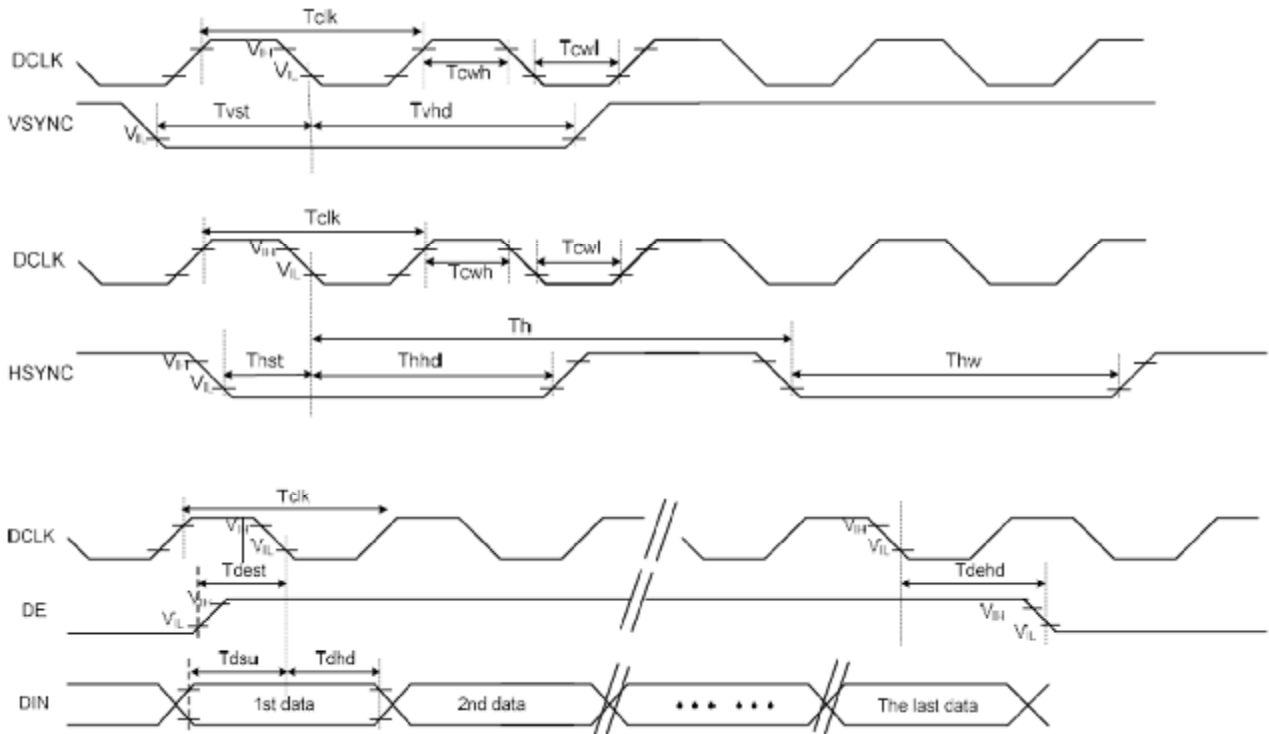

Item	Symbol	Min.	Typ.	Max.	Unit	Conditions
CLK Pulse Duty	T_{cw}	40	50	60	%	
HSYNC Width	T_{hw}	2	-	-	DCLK	
HSYNC Period	T_h	55	60	65	us	
VSYNC Setup Time	T_{vst}	12	-	-	ns	
VSYNC Hold Time	T_{vhd}	12	-	-	ns	
HSYNC Setup Time	T_{hst}	12	-	-	ns	
HSYNC Hold Time	T_{hhd}	12	-	-	ns	
Data Setup Time	T_{dsu}	12	-	-	ns	
Data Hold Time	T_{dhd}	12	-	-	ns	
DE Setup Time	T_{dest}	12	-	-	ns	
DE Hold Time	T_{dehd}	12	-	-	ns	



4.4.1.1 SYNC Mode

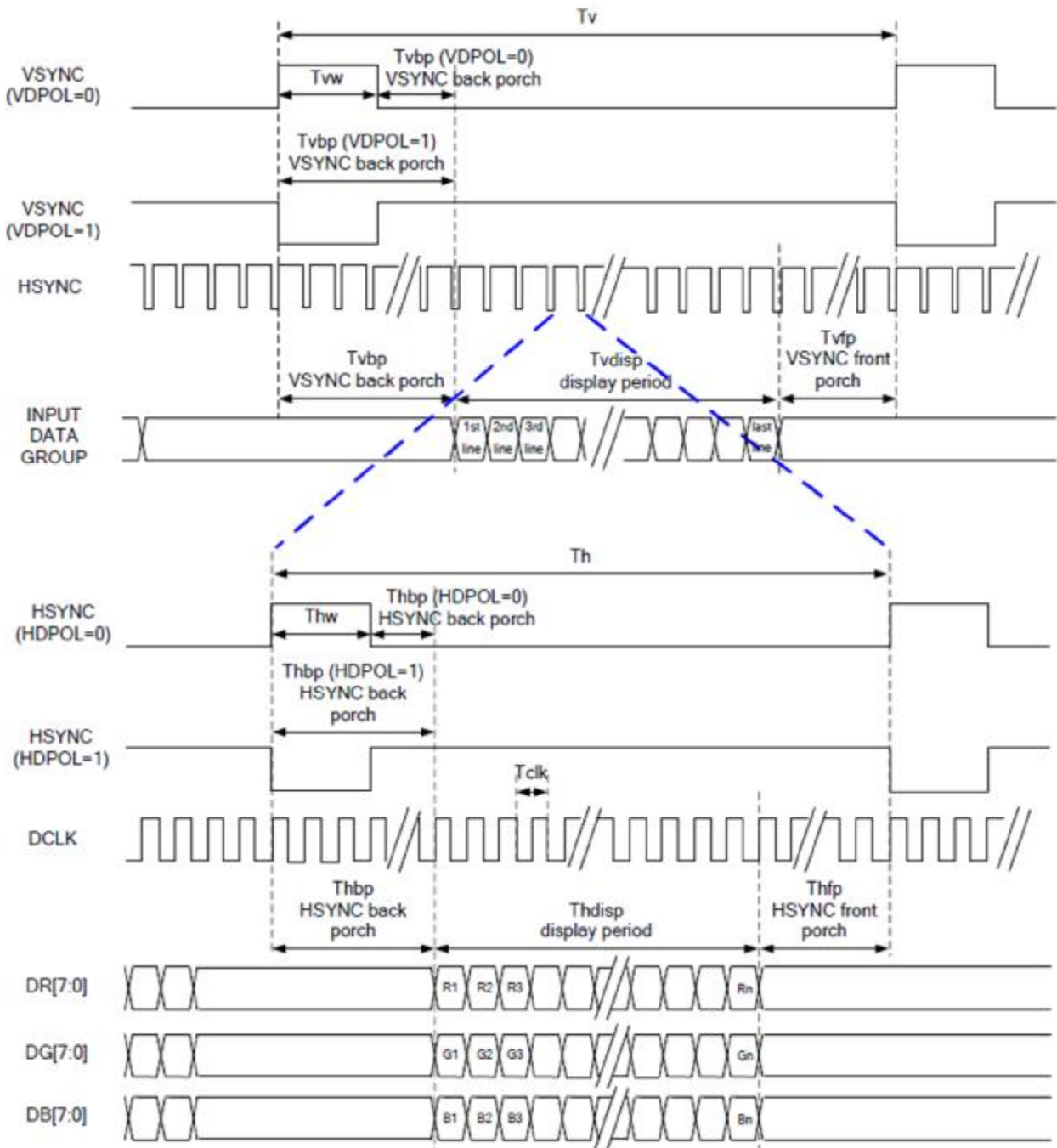



4.4.1.2 SYNC-DE Mode

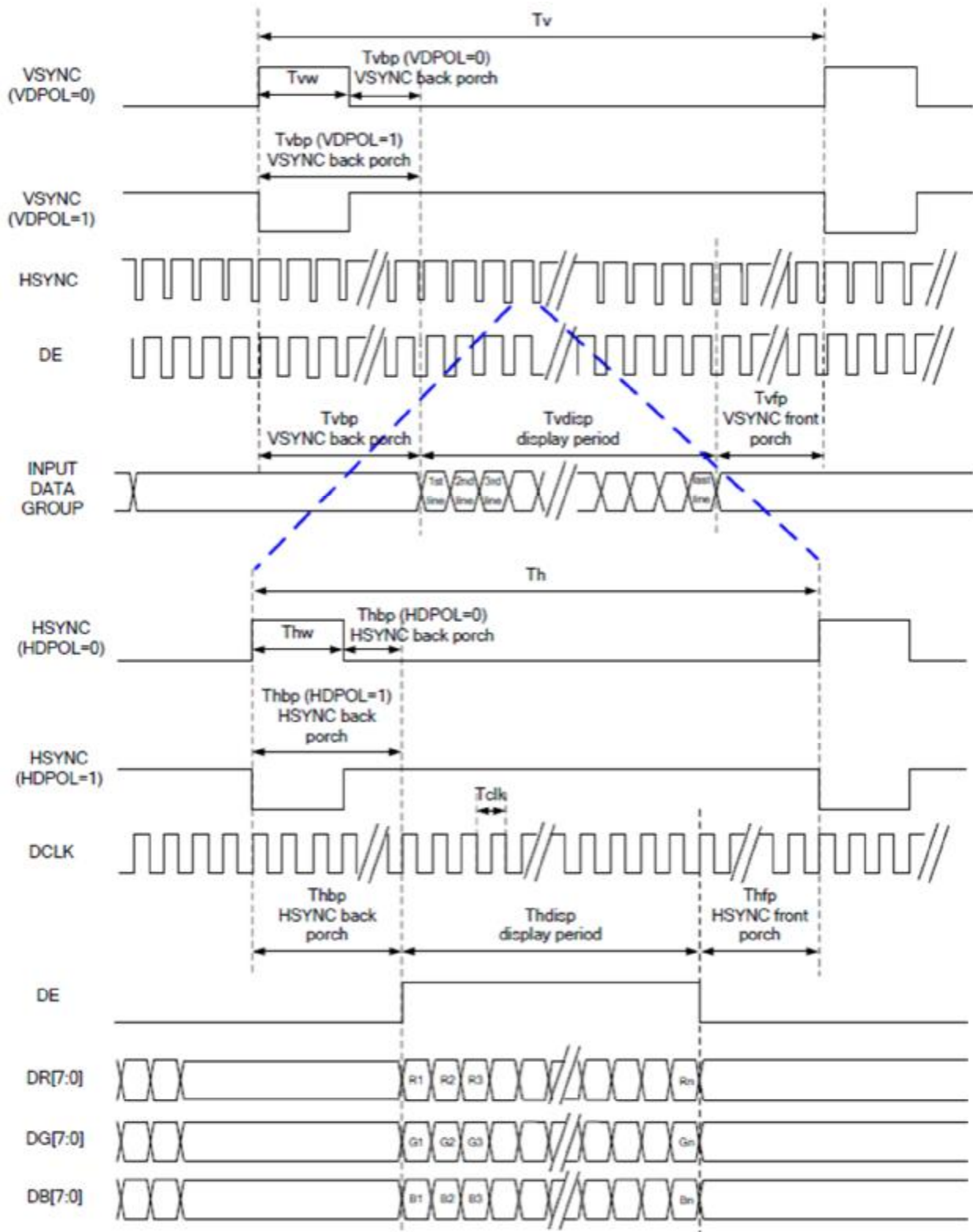



4.4.1.3 DE Mode

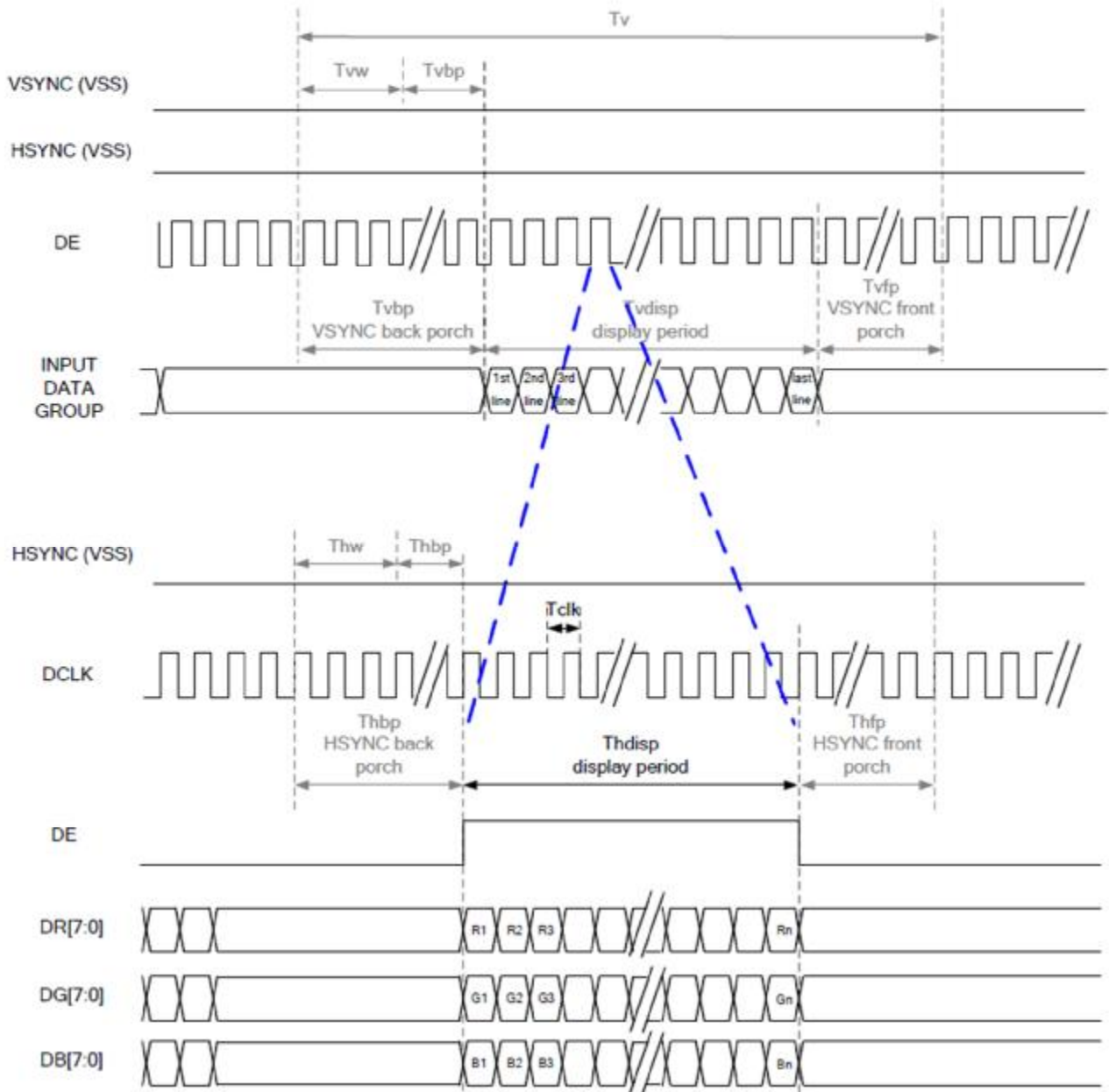



4.4.2 Parallel 24-bit RGB Input Timing

480RGB X 272 Resolution Timing Table							
Item	Symbol	Min.	Typ.	Max.	Unit	Remark	
DCLK Frequency	Fclk	8	9	12	MHz		
DCLK Period	Tclk	83	111	125	ns		
HSYNC	Period Time	Th	485	531	598	DCLK	
	Display Period	Thdisp		480		DCLK	
	Back Porch	Thbp	3	43	43	DCLK	By H_BLANKING setting
	Front Porch	Thfp	2	8	75	DCLK	
	Pulse Width	Thw	2	4	43	DCLK	
VSYNC	Period Time	Tv	276	292	321	HSYNC	
	Display Period	Tvdisp		272		HSYNC	
	Back Porch	Tvbp	2	12	12	HSYNC	By V_BLANKING setting
	Front Porch	Tvfp	2	8	37	HSYNC	
	Pulse Width	Tvw	2	4	12	HSYNC	



4.5 Pin Assignment Table

Pin No.	Symbol	I/O	Description	Note
1	VLED-	P	Backlight -ve	
2	VLED+	P	Backlight +ve	
3	GND	P	Ground	
4	VDD	P	Power Supply	
5-12	R0~R7	I	Red Data Bus (R0 ~ R7)	
13-20	G0~G7	I	Green Data Bus (G0 ~ G7)	
21-28	B0~B7	I	Blue Data Bus (B0 ~ B7)	
29	GND	P	Ground	
30	PCLK	I	Data Clock	
31	DISP	I	Display ON/OFF	(1)
32	HSYNC	I	Line Synchronization Signal	
33	VSYNC	I	Frame Synchronization Signal	
34	DE	I	Data Enable	
35	NC	-	No Connection	
36	GND	P	Ground	
37	NC / XR	O	For Resistive Touch Panel Only	
38	NC / YD	O		
39	NC / XL	O		
40	NC / YU	O		

Note:

(1) Set high for Display ON, low for Display OFF.

5. AC/DC Characteristics (RTP)

5.1 Electrical Characteristics

Item	Value
Rated voltage	DC5V
Rated Current	1mA
Resistance between terminals	X direction[Glass side]: 150-900Ω
	Y direction [Film side]: 150-900Ω
Insulation resistance	DC 25V, $\geq 20M\Omega$
Linearity	$\leq 1.5\%$
Chattering Time	$\leq 15ms$

5.2 Structure

The Structure and the performance guarantee area of this touch panel are defined as below:-

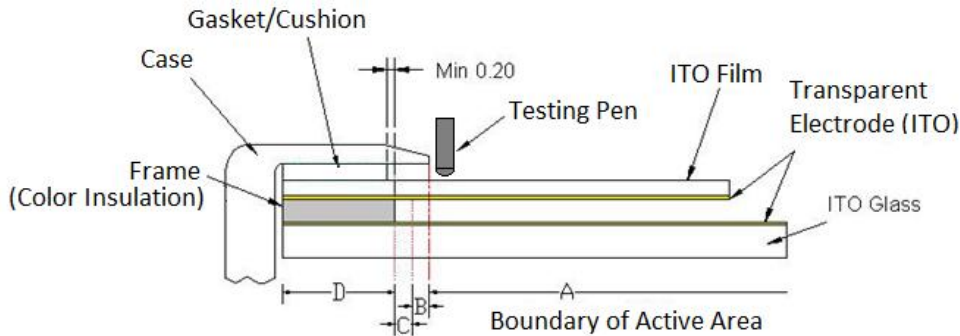

A Area: Active Area

The area guarantees a touch panel operation with the following characteristics when pressed:-

1. Operation Force
2. Electrical Characteristic
3. Tapping durability
4. Pen Sliding durability

B Area: Operation non-guaranteed area

This area is about 0.5mm outside the Active Area (A)

The area does not guarantee a touch panel operation and its function. When this area is pressed, touch panel shows degradation of its performance and durability such as a pen sliding durability becomes about 10% compared with the Active Area (as guaranteed area) and its operation force requires about double.

C Area: Pressing Prohibition area

This area is about 0.5mm outside the B area

Any Pressing force must be avoided from this area because an excessive load is applied to a transparent electrode and it will cause serious damage to the touch panel function.

D Area: Non Active Area

This area does not active even if pressed.

In order to prevent unusual performance degradation or malfunction of the touch panel, the casing must be avoided from touching area B and C. Both area are sensitive area.

5.3 Test Condition

5.3.1 Mechanical Characteristic

5.3.1.1 Tapping durability

Using R8mm silicon rubber test on centre of active area. Testing continue until pass the criteria.

Condition	Criteria
Test position: any point in each side interval 2mm within active area. Test jig: 8mm silicon rubber, hardness 60° Test Force: 250gf Frequency: 2 times/sec	Up to 1000K times without any function failure

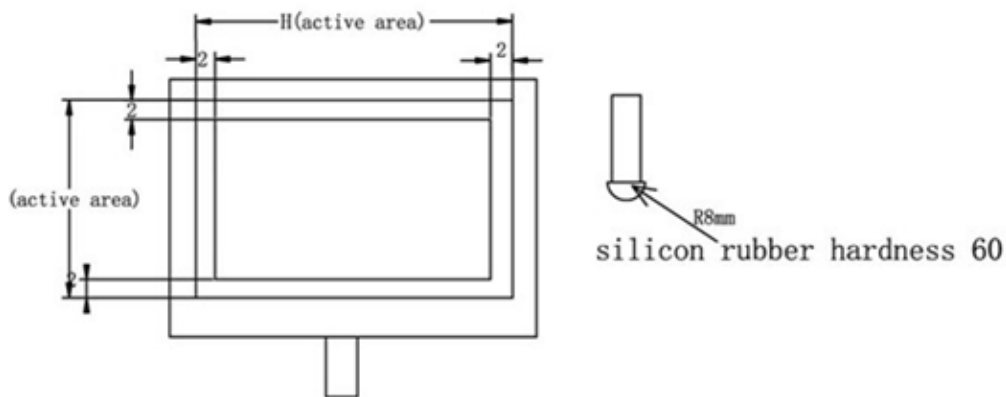

5.3.1.2 Pen sliding durability

condition	criteria
Test area : each side interval 3mm within active area Test jig :R 0.8mm polyacetal pen Input force:150gf Freauencv:60mm/sec	No function fail after 100K times 1 time means sliding from A to B or B to A

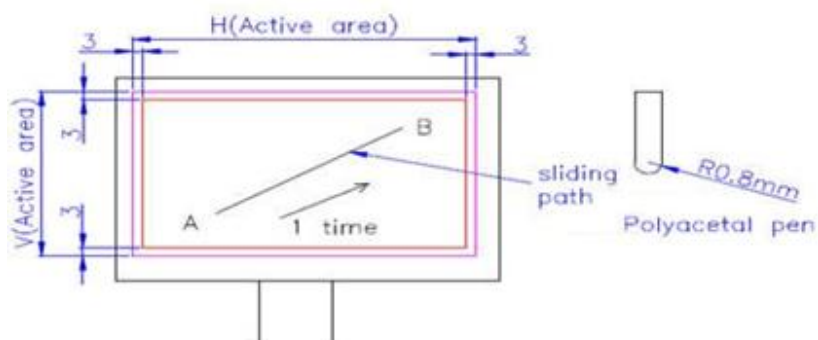

Operation force: 120g max (tip R0.8mm Polyacetal pen operation and R8mm silicon rubber, interval 2mm within Active area.

5.3.1.3 Impact Stress

Using free-fall stainless steel ball impact on the centre of touch panel active area.

The condition as below:-

Condition	Criteria
For 0.55t glass, use 9.0mm stainless steel ball, drop height=30cm	No function fail and no glass broken.
For 0.7t glass, use 9.0mm stainless steel ball, drop height=50cm	No function fail and no glass broken.
For 1.1t glass, use 9.0mm stainless steel ball, drop height=70cm	No function fail and no glass broken.
For 0.7t tempered glass, use 9.0mm stainless steel ball, drop height=70cm	No function fail and no glass broken.
For 1.1t tempered glass, use 9.0mm stainless steel ball, drop height=90cm	No function fail and no glass broken.

5.3.1.4 Surface Pressure

The method is use a flat pressed on ITO film, plate area is defined by touch panel size.

Condition	Criteria
Loading: 500gf. Test time : 30min size: H x V RTP size: more than 9inch: 10cm x 7cm RTP size : 5.5inch - 9inch: 7cm x 5cm RTP size: Less than 5.5inch: 3cm x 3cm	No visual defect No functional failure

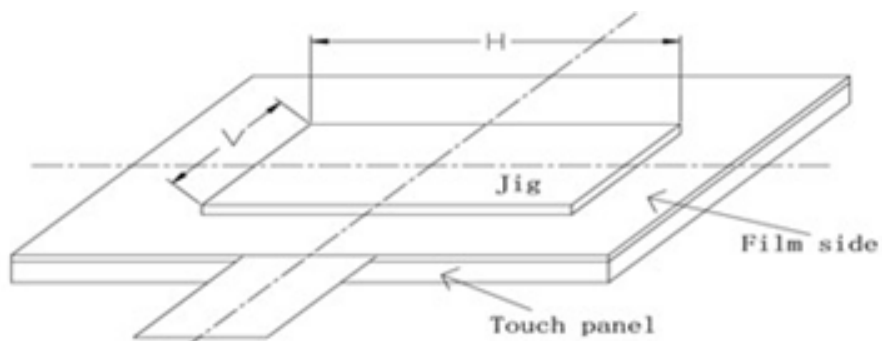



6. AC/DC Characteristics (CTP)

6.1 Absolute Maximum Ratings ($V_{SS} = 0V$, $T_a = 25^{\circ}C$)

Item	Symbol	Min	Typ	Max	Unit	Note
Power Supply Voltage	VCC	1.8	-	3.6	V	
Storage Humidity	HST	10	-	90	%RH	(1)
Storage Temperature	TST	-30	-	+80	$^{\circ}C$	
Operating Humidity	HOP	10	-	90	%RH	(1)
Operating Temperature	TOP	-20	-	+70	$^{\circ}C$	

Note:

- (1) At $25 \pm 5^{\circ}C$. Absolute humidity shall be less than 90%RH at $+60^{\circ}C$.
- (2) Stresses above those listed under "Absolute Maximum Ratings" may cause permanent damage to the device. These are stress ratings only. Functional operation of this device at these or any other conditions above those indicated in the operational sections of this specification is not implied and exposure to absolute maximum rating conditions for extended periods may affect device reliability.

6.2 Electrical Characteristics ($V_{SS} = 0V$, $V_{CC} = 3.3V$, $T_a = 25^{\circ}C$)

Item	Symbol	Min	Typ	Max	Unit	Note
Power Supply Voltage	VCC	2.7	-	3.6	V	
Operation Current	I _{cc}	-	4.5	6.0	mA	
Low Level Input Voltage	V _{IL}	-0.3	-	0.3V _{CC}	V	
High Level Input Voltage	V _{IH}	0.7V _{CC}	-	V _{CC}	V	
Low Level Output Voltage	V _{OL}	-	-	0.3V _{CC}	V	
High Level Output Voltage	V _{OH}	0.7V _{CC}	-	-	V	
I/O Leakage current	I _{LI}	-1	-	1	μA	

Note:

- (1) The recommended operating conditions refer to a range in which operation of this product is guaranteed. Accordingly, please make sure that the module is used within this range. And these current values are measured under the condition that all devices are stopped, each component is stable and logic signal is input.

6.3 I2C Interface

Touch panel is used as I2C slave device, I2C slave address is 0x70, refer FT5446 datasheet for details.

There are three communication pins connected between host and CTP module which are including external interrupt INT, I2C pins SCL and SDA. The INT is active low while the touch state is calculated by CTP module and the touch information can be translated via I2C communication interface.



6.4 I2C Timing Characteristics (VSS = 0V, VCC = 3.3V, Ta = 25°C)

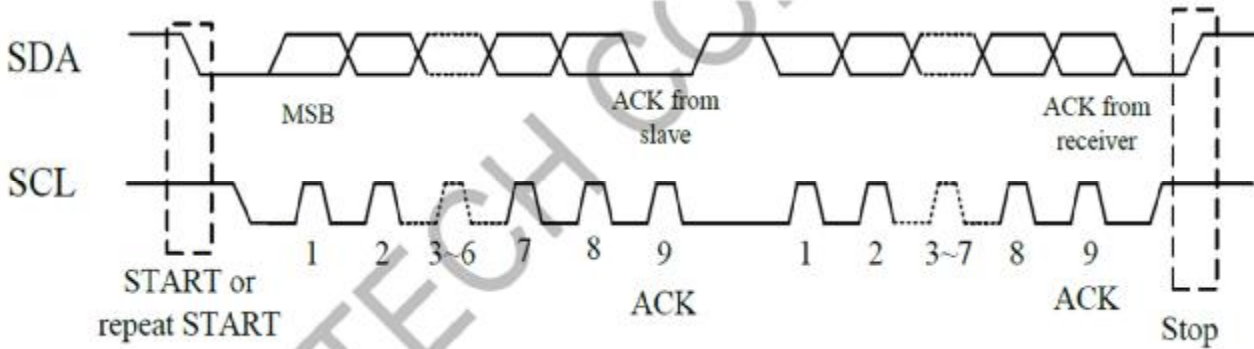

Parameter	Min	Max	Unit
SCL frequency	0	400	KHz
Bus free time between a STOP and START condition	1.3		us
Hold time (repeated) START condition	0.6		us
Data setup time	100		ns
Setup time for a repeated START condition	0.6		us
Setup Time for STOP condition	0.6		us

6.5 Pin Assignment Table

Pin No.	Symbol	I/O	Description	Note
1 - 5	GND	P	Ground	
6	VCC	P	Power Supply	
7	INT	O	Interrupt	(1)
8	WAKE UP	I	Reset	(2)
9	SCL	I	I2C Serial Clock	
10	SDA	I/O	I2C Serial Data	

Note:

(1) INT (CTP) : Active low

(2) WAKE UP (CTP) : Low to reset

7. Optical Characteristics

Item	Symbol	Condition	Min	Typ	Max	Unit	Note
Brightness	Bp	$\theta=0^\circ$	500	650	800	cd/m ²	(2)
Uniformity	ΔBp	$\Phi=0^\circ$	63	-	-	%	(2)(3)
Viewing Angle	3:00	Cr \geq 10	70	80	-	degree	(4)
	6:00		70	80	-		
	9:00		70	80	-		
	12:00		70	80	-		
Contrast Ratio	Cr	$\theta=0^\circ$ $\Phi=0^\circ$	640	800	-	-	(5)
Response Time	Tr + Tf		-	30	40	ms	(6)
NTSC Ratio	S		45	50	-	%	(7)
CTP Transmittance	T		85	90	-	%	(8)

Note:

- (1) The parameter is slightly changed by temperature, driving voltage and materiel.
- (2) The data are measured after LEDs are turned on for 5 minutes. LCM displays full white. The brightness is the average value of 5 measured spots. Measurement equipment BM-7A.
 Measuring condition:
 - Measuring surroundings: Dark room.
 - Measuring temperature: Ta=25°C.
 - Adjust operating voltage to get optimum contrast at the center of the display.
 Measured value at the center point of LCD panel after more than 5 minutes while backlight turning on.

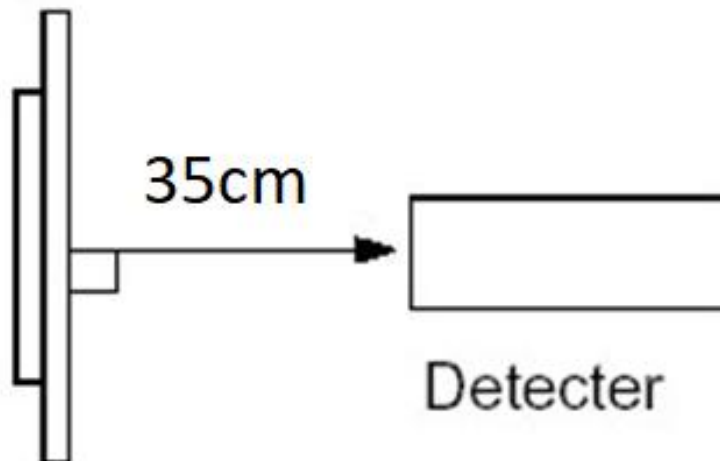

(3) The luminance uniformity is calculated by using following formula:

$$\Delta Bp = Bp (\text{Min.}) / Bp (\text{Max.}) \times 100 (\%)$$

Bp (Max.) = Maximum brightness in 5 measured spots.

Bp (Min.) = Minimum brightness in 5 measured spots.

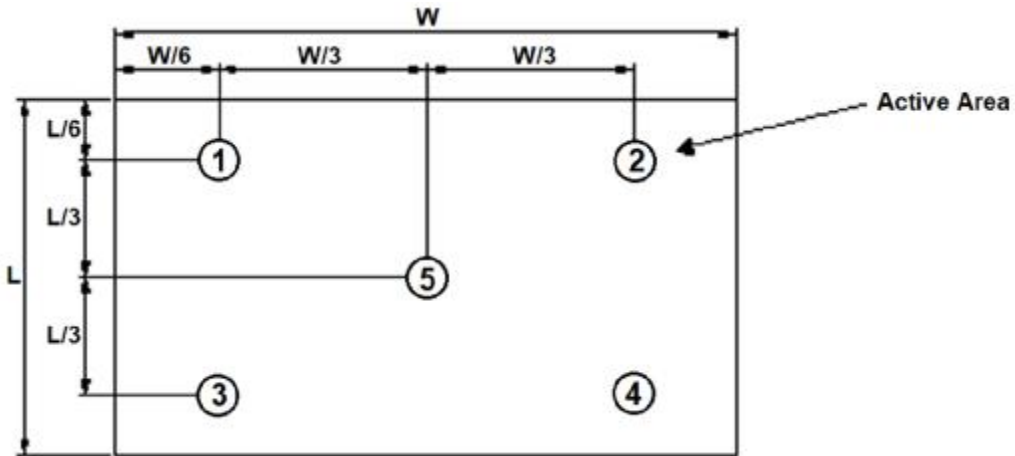

(4) The definition of viewing angle:

Refer to the graph below marked by θ and ϕ

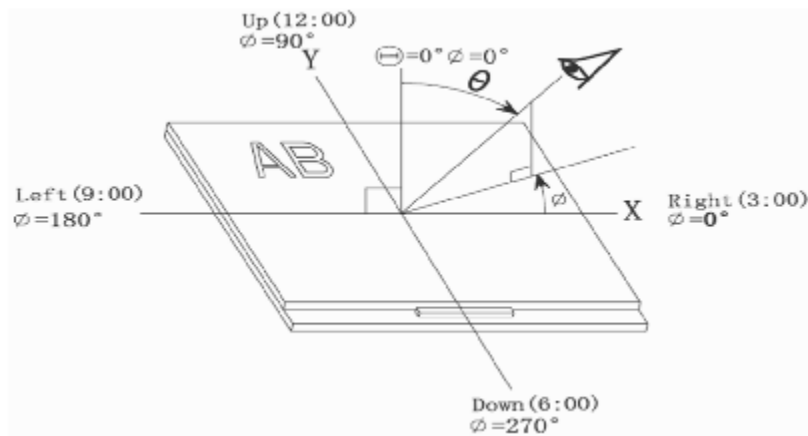

(5) Definition of contrast ratio.

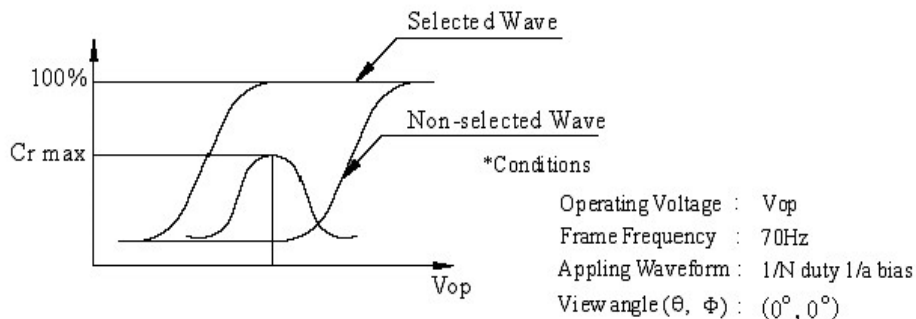

$$\text{Contrast ratio (Cr)} = \frac{\text{Brightness of selected dots}}{\text{Brightness of non-selected dots}}$$



(6) Definition of Response time.

The output signals of photo detector are measured when the input signals are changed from “black” to “white” (falling time) and from “white” to “black” (rising time), respectively. The response time is defined as the time interval between the 10% and 90% of amplitudes. Refer to figure as below.

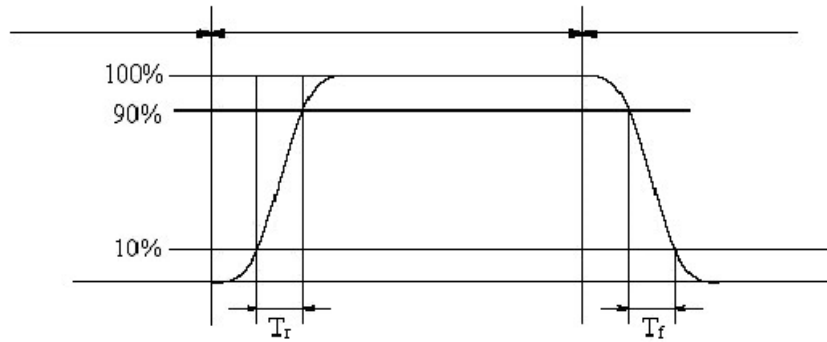

The Definition of response time

(7) Definition of Color of CIE Coordinate and NTSC Ratio.

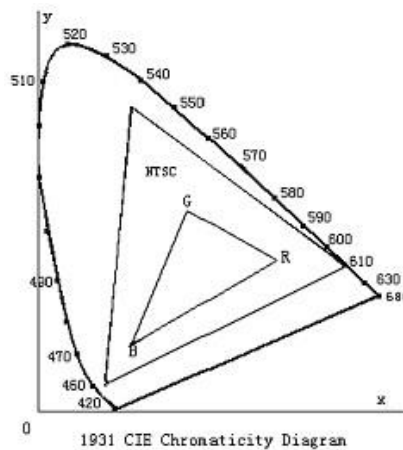

(8) Definition of The transmittance measurements shall be made at viewing angle of $\theta = 0^\circ$ and at the center of the touch panel by using BM-7A. Transmittance shall be calculated by the difference of the luminance between a standard light source with touch panel and a standard light source without touch panel.

$$\text{Transmittance} = \frac{\text{Luminance on touch panel surface}}{\text{Luminance of standard light source}}$$



8. Reliability Test Condition

Item		Test Condition	Note
Operating	High Temperature	+70°C, 240hrs	(3)
	Low Temperature	-20°C, 240hrs	(3)
	High Temperature and High Humidity	+60°C, 90%RH, 240hrs	(3)(4)
	Cycle	RT (0m) à -20°C (30m) à RT (5m) à +70°C (30m) à RT (5m) 50 cycles	(1)(2)(3)
Storage	High Temperature	+80°C, 240hrs	(3)
	Low Temperature	-30°C, 240hrs	(3)

Note:

- (1) RT means Room Temperature.
- (2) m means minute.
- (3) Before cosmetic and functional test, the product must have enough recovery time, at least 2 hours at room temperature.
- (4) No condensation

9. Inspection Criteria

- Inspection distance: 25~30cm.
- From lamp source to product: 250 ± 100 cm.
- Angle of inspection: Ambient brightness 1k-1.5k lux inspection from front view, perpendicular to the surface of product.

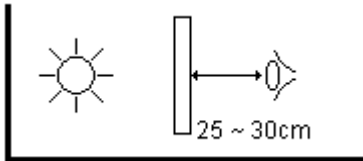



No	Defect	Definition of defect	Inspection Criteria												
1	a) Definition of dot	<p>The size of defective dot over $\frac{1}{2}$ of whole is regards as one defective dot.</p> <p>Smaller than $\frac{1}{2}$ Larger than $\frac{1}{2}$</p> <p>'No dot defect' (ignore) '1 dot defect' (counted)</p>	<p>A – Viewing Area B – Outside viewing area</p>												
	b) Bright Dot	Dot appear bright and unchanged in size when LCD panel is displaying black pattern.	<table border="1"> <tr> <td>Defect</td> <td>A</td> <td>B</td> </tr> <tr> <td>Bright Dot</td> <td>1</td> <td rowspan="3">NC</td> </tr> <tr> <td>Dark Dot</td> <td>2</td> </tr> <tr> <td>Total</td> <td>3</td> </tr> </table> <p>NC – Not Count</p>	Defect	A	B	Bright Dot	1	NC	Dark Dot	2	Total	3		
	Defect	A		B											
	Bright Dot	1	NC												
Dark Dot	2														
Total	3														
c) Dark Dot	Dot appear dark and unchanged in size when LCD panel is displaying pure color (RED, GREEN or BLUE) pattern.														
d) 2 dot adjacent	<p>1 pair = 2 dots</p> <p>Type 1 Type 2</p> <p>or</p> <p>Type 3</p>	<table border="1"> <tr> <td>Defect</td> <td>Acc. Count</td> </tr> <tr> <td>2 Bright dot Adjacent</td> <td>0</td> </tr> <tr> <td>2 Dark dot Adjacent</td> <td>1</td> </tr> </table>	Defect	Acc. Count	2 Bright dot Adjacent	0	2 Dark dot Adjacent	1							
Defect	Acc. Count														
2 Bright dot Adjacent	0														
2 Dark dot Adjacent	1														
2	<p>a) Black Spot b) White Spot c) Bright Spot d) Pin Hole e) Foreign Particle</p>	<p>- Black / Dark / Bright Spot is points on display which appear dark/bright and usually result from contamination.</p> <p>- These defect do not vary in size intensity (contrast) when contras is varied.</p>	<table border="1"> <tr> <td>Defect Category</td> <td>A</td> <td>B</td> </tr> <tr> <td>$D < 0.10$</td> <td>NC</td> <td rowspan="4">NC</td> </tr> <tr> <td>$0.10 \leq D \leq 0.15$</td> <td>2</td> </tr> <tr> <td>$0.15 \leq D \leq 0.20$</td> <td>1</td> </tr> <tr> <td>$D > 0.2$</td> <td>0</td> </tr> </table>	Defect Category	A	B	$D < 0.10$	NC	NC	$0.10 \leq D \leq 0.15$	2	$0.15 \leq D \leq 0.20$	1	$D > 0.2$	0
Defect Category	A	B													
$D < 0.10$	NC	NC													
$0.10 \leq D \leq 0.15$	2														
$0.15 \leq D \leq 0.20$	1														
$D > 0.2$	0														



	<p>a) Black Line b) White Line c) Particle between POL and Glass d) Scratch on Glass</p>		<table border="1"> <thead> <tr> <th>Defect Category</th> <th>A</th> <th>B</th> </tr> </thead> <tbody> <tr> <td>$W < 0.03$</td> <td>NC</td> <td rowspan="3">NC</td> </tr> <tr> <td>$0.03 \leq W \leq 0.05$, $L \leq 2.0$</td> <td>2</td> </tr> <tr> <td>$W > 0.05$</td> <td>0</td> </tr> </tbody> </table>	Defect Category	A	B	$W < 0.03$	NC	NC	$0.03 \leq W \leq 0.05$, $L \leq 2.0$	2	$W > 0.05$	0		
Defect Category	A	B													
$W < 0.03$	NC	NC													
$0.03 \leq W \leq 0.05$, $L \leq 2.0$	2														
$W > 0.05$	0														
	<p>a) POL Bubble b) POL Dented</p>		<table border="1"> <thead> <tr> <th>Defect Category</th> <th>A</th> <th>B</th> </tr> </thead> <tbody> <tr> <td>$D < 0.20$</td> <td>NC</td> <td rowspan="4">NC</td> </tr> <tr> <td>$0.20 \leq D \leq 0.30$</td> <td>3</td> </tr> <tr> <td>$0.30 \leq D \leq 0.50$</td> <td>2</td> </tr> <tr> <td>$D > 0.5$</td> <td>0</td> </tr> </tbody> </table>	Defect Category	A	B	$D < 0.20$	NC	NC	$0.20 \leq D \leq 0.30$	3	$0.30 \leq D \leq 0.50$	2	$D > 0.5$	0
Defect Category	A	B													
$D < 0.20$	NC	NC													
$0.20 \leq D \leq 0.30$	3														
$0.30 \leq D \leq 0.50$	2														
$D > 0.5$	0														
3	Mura (50% Grey)		Judged by Limit sample												
4	Corner Chip		<p>Accept if (only allowed 1):- a) $X \leq 1.0\text{mm}$ b) $Y \leq 1.0\text{mm}$ c) $Z \leq 1/2T$</p>												
	Edge Chip	<p>- Touch sensor corner and edge chip that do not cause any damage to tracer and not visible to end-user after housing assembly. - Lens edge and corner chip that is not visible to end-user after housing assembly.</p>	<p>Accept if (only allowed 1):- a) $X \leq 1.0\text{mm}$ b) $Y \leq 1.0\text{mm}$ c) $Z \leq 1/2T$</p> <p>Reject – if the sensor surface edge/corner chip damage circuit and visible from front view</p>												
	Glass Crack		Reject – if any crack												

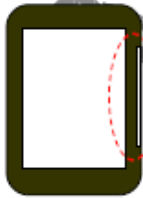
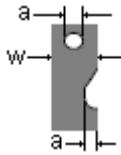

5	Printing Ink Light Leakage		<p>Accept if:- Light leakage at marginal area width $\leq 0.15\text{mm}$</p> 
6	Surface Smudginess	<p>- For those that can be cleaned, $\leq 20\%$ of inspected quantity in one lot under > class 10K area; $\leq 10\%$ of inspected quantity in one lot \leq class 10K area. - For those that cannot be cleaned it is classified as foreign round shape defect.</p>	
7	FPC Defects on Contact Pad		<p>Accept if dent, pinhole:- a) $a \leq w/3$</p>  <p>Reject – if open circuit / cracking / oxidation / contamination</p>
	FPC Broken		Reject if FPC broken / extruded
	FPC Warped		Accept if FPC warped



10. Precaution

1. Handling Precautions

- a. The display panel is made of glass and polarizer. As glass is fragile. It tends to chip during handling especially on the edges. Please avoid dropping or jarring. Do not subject it to a mechanical shock of impact or by dropping it.
- b. If the display panel is damaged and the liquid crystal substance leaks out, be sure not to get any in your mouth. If the substance is in contact with your skin or clothes, wash it off using soap and water.
- c. Do not apply excessive force to the display surface or the adjoining areas since this may cause the color tone to vary. Do not touch the display with bare hands. This will stain the display area and degrade the insulation between terminals. Scratch and dents may occur on polarizer too.
- d. The polarizer covering the display surface of the LCD module is soft and easily scratched. Handle this polarizer carefully. Do not touch, push or rub the exposed polarizers with anything harder than a HB pencil lead (glass, tweezers, etc.). Do not put or attach anything on the display area to avoid leaving marks on it. Condensation on the surface and contact with terminals due to cold will damage, stain or dirty the polarizer. After products are tested at low temperature they must be warmed up in a container before coming in to contact with room temperature air.
- e. If the display surface becomes contaminated, breathe on the surface and gently wipe it with a soft dry cloth. If it is heavily contaminated, moisten cloth with one of the following solvents.
 - Isopropyl alcohol.
 - Ethyl alcohol.
 - Do not scrub hard to avoid damaging the display surface.
- f. Solvents other than those above-mentioned may damage the polarizer. Especially, do not use the following.
 - Water.
 - Ketone.
 - Aromatic solvents.
 - Wipe off saliva or water drops immediately, contact with water over a long period of time may cause deformation or colour fading. Avoid contact with oil and fats.
- g. Exercise care to minimize corrosion of the electrode. Corrosion of the electrodes is accelerated by water droplets, moisture condensation or a current flow in a high-humidity environment.
- h. Install the LCD Module by using the mounting holes. When mounting the LCD module make sure it is free of twisting, warping and distortion. In particular, do not forcibly pull or bend the I/O cable or the backlight cable.
- i. Do not attempt to disassemble or process the LCD module.
- j. NC terminal should be open. Do not connect anything.
- k. If the logic circuit power is off, do not apply the input signals.
- l. Electro-Static Discharge Control. Since this module uses a CMOS LSI, the same careful attention should be paid to electrostatic discharge as for an ordinary CMOS IC. To prevent destruction of the elements by static electricity, be careful to maintain an optimum work environment.
 - Before removing LCM from its packing case or incorporating it into a set, be sure the module and your body have the same electric potential. Be sure to ground the body when handling the LCD modules.
 - Tools required for assembly, such as soldering irons, must be properly grounded. Make certain the AC power source for the soldering iron does not leak. When using an electric screwdriver to attach LCM, the screw driver should be of ground potentiality to minimize as much as possible any transmission of electromagnetic waves produced sparks coming from the commutator of the motor.



- To reduce the amount of static electricity generated, do not conduct assembly and other work under dry conditions. To reduce the generation of static electricity be careful that the air in the work environment is not too dry. A relative humidity of 50%-60% is recommended. As far as possible make the electric potential of your work clothes and that of the work bench the ground potential.
- The LCD module is coated with a film to protect the display surface. Exercise care when peeling off this protective film since static electricity may be generated.
- m. Since LCM has been assembled and adjusted with a high degree of precision, avoid applying excessive shocks to the module or making any alterations or modifications to it.
 - Do not alter, modify or change the shape of the tab on the metal frame.
 - Do not make extra holes on the printed circuit board, modify its shape or change the positions of components to be attached.
 - Do not damage or modify the pattern writing on the printed circuit board.
 - Absolutely do not modify the zebra rubber strip (conductive rubber) or heat seal connector.
 - Except for soldering the interface, do not make any alterations or modifications with a soldering iron.
 - Do not drop, bend or twist the LCM.

2. Storage Precautions

When storing the LCD modules, the following precaution are necessary.

- a. Store the LCD at a temperature from 10°C to 30°C and a relative humidity of 65% RH or less.
- b. Please store display in a dry place and shelter from direct sunlight.

3. Others

- a. Liquid crystals solidify under low temperature (below the storage temperature range) leading to defective orientation or the generation of air bubbles (black or white). Air bubbles may also be generated if the module is subject to a low temperature.
- b. If the LCD modules have been operating for a long time showing the same display patterns, the display patterns may remain on the screen as ghost images and a slight contrast irregularity may also appear. A normal operating status can be regained by suspending use for some time. It should be noted that this phenomenon does not adversely affect performance reliability.
- c. To minimize the performance degradation of the LCD modules resulting from destruction caused by static electricity etc. Exercise care to avoid holding the following sections when handling the modules.
 - Exposed area of the printed circuit board.
 - Terminal electrode sections.

4. Using LCD Modules

a. Installing LCD Modules

The hole in the printed circuit board is used to fix LCM as shown in the picture below. Attend to the following items when installing the LCM.

- b. Cover the surface with a transparent protective plate to protect the polarizer and LC cell.

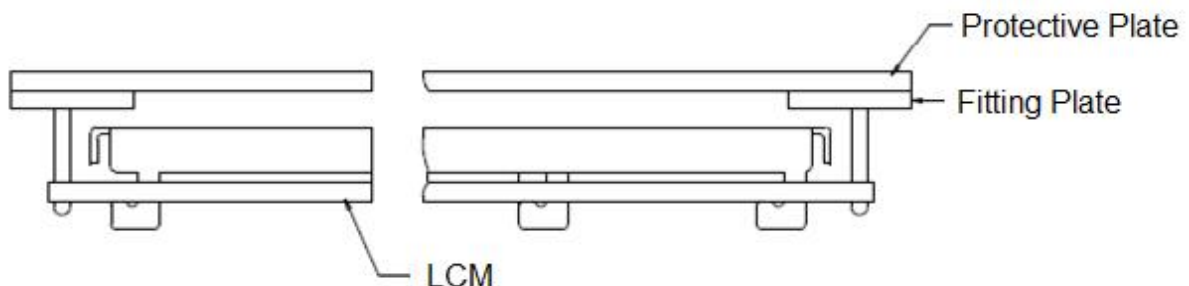

- c. When assembling the LCM into other equipment, the spacer to the bit between the LCM and the fitting plate should have enough height to avoid causing stress to the module surface, refer to the individual specifications for measurements. The measurement tolerance should be 0.1mm.
- d. Precaution for assemble the module with BTB connector:
Please note the position of the male and female connector position, don't assemble or assemble like the method which the following picture shows.

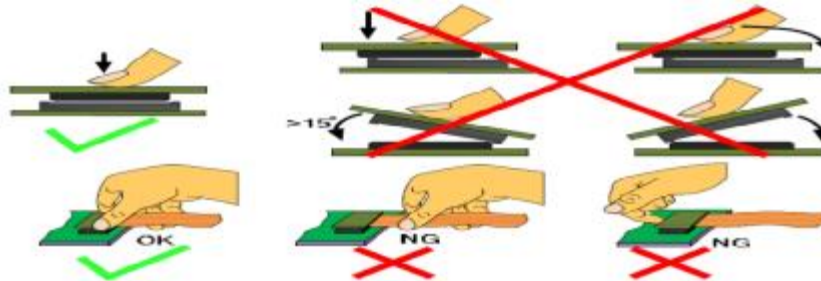

5. Precaution for soldering the LCM

	Manual soldering	Machine drag soldering	Machine press soldering
No RoHS Product	290°C ~350°C. Time: 3-5S.	330°C ~350°C. Speed: 4-8 mm/s.	300°C ~330°C. Time: 3-6S. Press: 0.8~1.2Mpa
RoHS Product	340°C ~370°C. Time: 3-5S.	350°C ~370°C. Time: 4-8 mm/s.	330°C ~360°C. Time: 3-6S. Press: 0.8~1.2Mpa

- a. If soldering flux is used, be sure to remove any remaining flux after finishing the soldering operation (This does not apply in the case of a non-halogen type of flux). It is recommended that you protect the LCD surface with a cover during soldering to prevent any damage due to flux spatters.
- b. When soldering the electroluminescent panel and PC board, the panel and board should not be detached more than three times. This maximum number is determined by the temperature and time conditions mentioned above, though there may be some variance depending on the temperature of the soldering iron.
- c. When removing the electroluminescent panel from the PC board, be sure the solder has completely melted, the soldered pad on the PC board could be damaged.

6. Precautions for Operation

- a. Viewing angle varies with the change of liquid crystal driving voltage (VLCD). Adjust VLCD to show the best contrast.
- b. It is recommended to drive LCD's within the specified voltage limit since over limit will cause shorter LCD life. An electrochemical reaction due to direct current causes LCD deterioration. Avoid the use of direct current drive.
- c. Response time will be extremely delayed at lower temperature compared to room operating temperature range and on the other hand, at higher temperature LCD-shows dark colour in them. However those phenomena do not mean malfunction. The LCD will return to normal performance when ambient temperature revert to room condition.
- d. If the display area is pushed hard during operation, the display will become abnormal. However, it will return to normal if it is turned off and on.
- e. A slight dew depositing on terminals is a cause for electro-chemical reaction resulting in terminal open circuit.
- f. Input logic voltage before apply analogue high voltage such as LCD driving voltage when power on. Remove analogue high voltage before logic voltage when power off the module. Input each signal after the positive/negative voltage becomes stable.



- g. Please keep the temperature within the specified range for use and storage. Polarization degradation, bubble generation or polarizer peel-off may occur with high temperature and high humidity.

7. Safety

- a. It is recommended to crush damaged or unnecessary LCDs into pieces and wash them off with solvents such as acetone and ethanol, which should later be burned.
- b. If any liquid leaks out of a damaged glass cell and comes in contact with the hands, wash off thoroughly with soap and water.

8. Limited Warranty

Unless otherwise agreed between Crystal Clear Technology and customer, Crystal Clear Technology will replace or repair any of its LCD and LCM which is found to be defective electrically and visually when inspected in accordance with Crystal Clear Technology acceptance standards, for a period of one year from date of shipment. Confirmation of such date shall be based on freight documents. The warranty liability of Crystal Clear Technology is limited to repair and/or replacement on the terms set forth above. Crystal Clear Technology will not responsible for any subsequent or consequential events.

9. Return LCM under Warranty

No warranty can be granted if the precautions stated above have been disregarded. The typical examples of violations are:

- Broken LCD glass.
- PCB eyelet's damaged or modified.
- PCB conductors damaged.
- Circuit modified in any way, including addition of components.
- PCB tampered with by grinding, engraving or painting varnish.
- Soldering to, or modifying the bezel in any manner.

Module repairs will be invoiced to customer upon mutual agreement. Modules must be returned with sufficient description of failure or defects. Any connectors or cable installed by customer must be removed completely without damaging the PCB eyelet's, conductors and terminals.



11. Mechanical Specification

