

# CRYSTAL CLEAR TECHNOLOGY

## Product Specification

**T700A05X00**

(REVISION1)

**Crystal Clear Technology Sdn. Bhd.**

16 Jalan TP5, Taman Perindustrian Sime UEP,

47600 Subang Jaya, Selangor DE

Tel: +603-80247099

Website: [www.cct.com.my](http://www.cct.com.my)

---





2.0 Records of Revision

Rev	Date	Item	Page	Comment	Originator	Checked By
1.0	12.07.16			Initial Release	Adam	Azhar



3.0 General Specification

T700A05X00 is 7.0" color TFT-LCD (Thin Film Transistor Liquid Crystal Display) module composed of LCD panel, driver ICs control circuit, LED backlight. This display area contains 800 x 1280 pixels and can display up to 16M colors. This product compliant with RoHS environmental requirement.

Item	Contents	Unit	Note
LCD Type	7.0" TFT	-	
Display color	16M		1
Viewing Direction (Optimum View)	ALL	O 'Clock	
Module size	99.85x161.7x2.6	mm	2
Active Area(W×H)	94.2x150.72	mm	
Number of Dots	800×RGB×1280	dots	
Controller		-	
Backlight	5x4 White LEDs	pcs	
Brightness	280 (typ)	cd/m2	3
Data Transfer	MIPI	-	

Note1: Color tone is slightly changed by temperature and driving voltage.

Note2: FPC or wire are not included.

Note3: Brightness on LCD surface. Module with CTP or RTP, brightness will be about 20% (max) lower on the touch panel surface.

AVAILABLE OPTION

X  0  0  X

TOUCH PANEL

N : Without Touch Panel  
 C : Capacitive Touch Panel  
 R : Resistive Touch Panel

SEMI - CUSTOMISE (MINOR CHANGES FROM STANDARD MODEL)  
 00 - STANDARD SPECIFICATION MODEL

OTHER OPTION

C : STANDARD COVER LENS

REFER TO FACTORY FOR FURTHER INFORMATION.  
 TERMS AND CONDITIONS APPLY



4.0 Absolute Maximum Ratings

4.1 Electrical Absolute Maximum ratings (V<sub>ss</sub> = 0V, T<sub>a</sub> = 25°C)

Item	Symbol	Min.	Max.	Unit	Note
Power Supply Voltage	VCC	-0.3	2.0	V	1, 2
Logic Signal Input /Output Voltage	VIOVCC	-0.3	VCC+0.5	V	
Power Supply Voltage for LCD	Vop	0	2.0	V	
Current of LED	ILED	0	80	mA/led	

Notes:

1. If the module is above these absolute maximum ratings. It may become permanently damaged.
2. V<sub>CC</sub> >V<sub>SS</sub> must be maintained.
3. Please be sure users are grounded when handing LCD Module.

4.2 Environmental Absolute Maximum Ratings

Item	Storage		Operating		Note
	MIN.	MAX.	MIN.	MAX.	
Ambient Temperature	-30°C	80°C	-20°C	70°C	1,2
Humidity	-	-	-	-	3

1. The response time will become lower when operated at low temperature.
2. Background color changes slightly depending on ambient temperature. The phenomenon is reversible.
3. T<sub>a</sub> ≤ 40°C and 85%RH MAX.  
(T<sub>a</sub> > 40°C. Absolute humidity must be lower than the humidity of 85%RH at 40°C)

**5.0 Electrical Characteristics and Instruction Code****5.1 Electrical Characteristics (V<sub>ss</sub> = 0V, T<sub>a</sub> = 25°C)**

Parameter	Symbol	Condition	Min	Typ	Max	Unit	Note
Power supply	VCC	T <sub>a</sub> =25°C	3.0		3.6	V	
Analog Power Supply Voltage	AVDD		9.4	9.6	9.8	V	
Gata On Power Supply Voltage	VGH		14	15	18	V	
Gata Off Power Supply Voltage	VGL		-12	-10	-8	V	
Common Power Supply Voltage	VCOM		-2.5	-	0	V	
Current Consumption	I <sub>CC1</sub>	Normal mode	-	-	-	mA	2

Note:

- 1: When an optimum contrast is obtained in transmissive mode.
- 2: Tested in 1X1 chessboard pattern.

**5.2 LED Backlight Specification (V<sub>ss</sub> = 0V, T<sub>a</sub> = 25°C)**

Item	Symbol	Condition	Min	Typ	Max	Unit	Note
Supply voltage	-	-	-	16	-	V	1
Supply current	I <sub>f</sub>	-	-	80	-	mA	2
Forward Current	Normal	I <sub>pn</sub>	5x4 chips series	-	80	-	mA
	Dimming	I <sub>pd</sub>		-	-	-	

Note:

1.  $V_{LED} = V_{LED (+)} - V_{LED (-)}$ .
2. It is recommended that customer supply constant current to prolong the led lifetime and optimum led performance
3. Definition of Lifetime: Luminance < 50% of initial Luminance  
(Test condition: T<sub>a</sub> = 25°C, Constant current supply (typical Value))

**5.3 Interface Signal**

Pin no	Symbol	Function	
1-3	VLED(A)	LED Anode	
4	NC	NC	
5-8	FB1-4(K)	LED Cathode	
9-10	GND	Ground	
11	MIPI-2P	MIPI Data lane2 input	
12	MIPI-2N	MIPI Data lane2 input	
13	GND	Ground	
14	MIPI-1P	MIPI Data lane1 input	
15	MIPI-1N	MIPI Data lane1 input	
16	GND	Ground	
17	MIPI-CLKP	MIPI CLK input	
18	MIPI-CLKN	MIPI CLK input	
19	GND	Ground	
20	MIPI-0P	MIPI Data lane0 input	
21	MIPI-0N	MIPI Data lane0 input	
22	GND	Ground	
23	MIPI-3P	MIPI Data lane3 input	
24	MIPI-3N	MIPI Data lane3 input	
25	GND	Ground	
26	ID	Connect a 500k $\Omega$ to GND	
27	RESET	Reset Pin	
28	NC	NC	
29-31	VDD	Power Supply	



6.0 Optical Characteristics

Items	Symbol	Condition	Min	Typ	Max	Unit	Remark
Response Time	Tr + Tf	$\Theta = 0^\circ$ $\varnothing = 0^\circ$ Ta = 25°C	-	30	40	ms	Note5
Contrast Ratio	Cr		600	800	-	-	Note4
Uniformity	$\Delta$ White		80	90	-	%	Note2
Surface Luminance	Lv		250	280	-	cd/m2	Note1
Viewing Angle	$\theta_3 = 90$	CR>10	80	85	-	°	Note3
	$\theta_9 = 270$		80	85	-		
	$\theta_{12} = 0$		80	85	-		
	$\theta_6 = 180$		80	85	-		
CIE (X, Y) Chromaticity	White	$X_W$	$\Theta = 0^\circ$ $\varnothing = 0^\circ$ Ta = 25°C Typ -0.03	0.3	Typ +0.03	-	Note6
		$Y_W$		0.32		-	
	Red	$X_R$		0.632		-	
		$Y_R$		0.311		-	
	Green	$X_G$		0.297		-	
		$Y_G$		0.536		-	
	Blue	$X_B$		0.140		-	
		$Y_B$		0.154		-	

Note: The parameter is slightly changed by temperature, driving voltage and materiel

Note 1: The data are measured after LEDs are turned on for 5 minutes. LCM displays full white. The brightness is the average value of 9 measured spots. Measurement equipment PR-705 (Φ8mm)

Measuring condition:

- Measuring surroundings: Dark room.
- Measuring temperature: Ta=25°C.
- Adjust operating voltage to get optimum contrast at the center of the display.

Measured value at the center point of LCD panel after more than 5 minutes while backlight turning on.



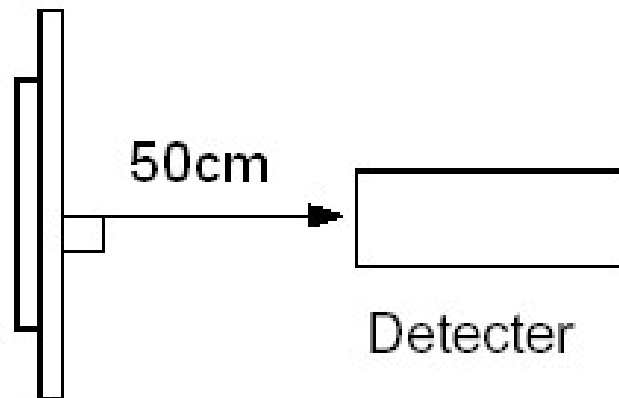

Note 2: The luminance uniformity is calculated by using following formula.

$$\Delta B_p = B_p (\text{Min.}) / B_p (\text{Max.}) \times 100 (\%)$$

$B_p (\text{Max.})$  = Maximum brightness in 9 measured spots  
 $B_p (\text{Min.})$  = Minimum brightness in 9 measured spots.

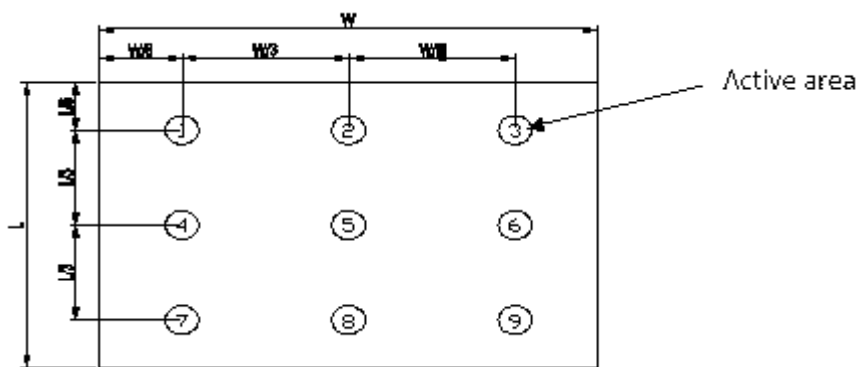

Note 3: The definition of viewing angle:

Refer to the graph below marked by  $\theta$  and  $\phi$

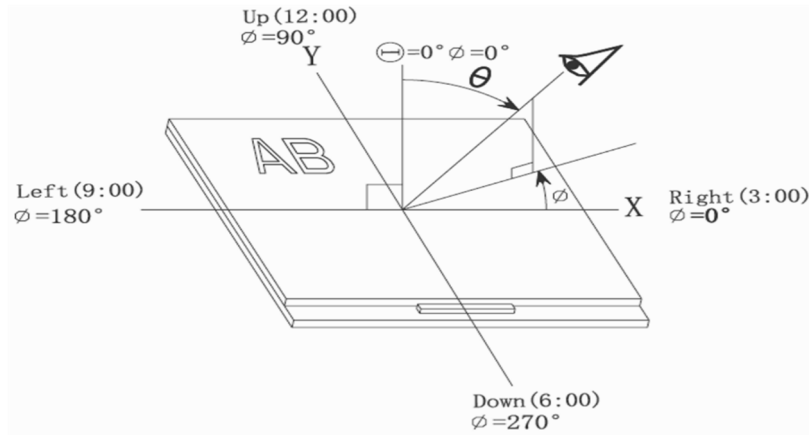

Note 4: Definition of contrast ratio. (Test LCD using DMS501)

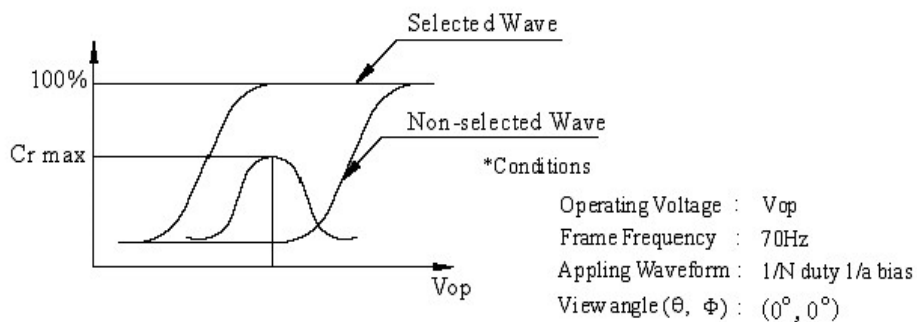

$$\text{Contrast ratio (Cr)} = \frac{\text{Brightness of selected dots}}{\text{Brightness of non-selected dots}}$$

Note 5: Definition of Response time. (Test LCD using DMS501):

The output signals of photo detector are measured when the input signals are changed from “black” to “white” (falling time) and from “white” to “black” (rising time), respectively. The response time is defined as the time interval between the 10% and 90% of amplitudes. Refer to figure as below.

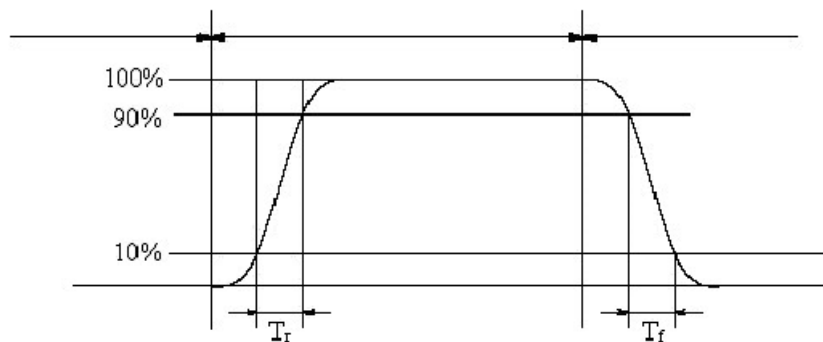

The Definition of response time

Note 6: Definition of Color of CIE Coordinate and NTSC Ratio.

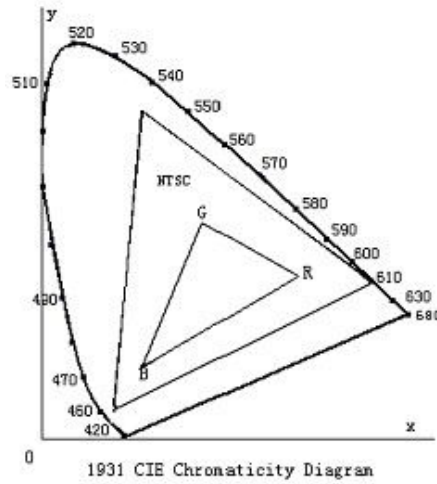

Note 7: Definition of cross talk.

$$\text{Cross talk ratio (\%)} = \frac{\text{pattern A Brightness} - \text{pattern B Brightness}}{\text{pattern A}}$$

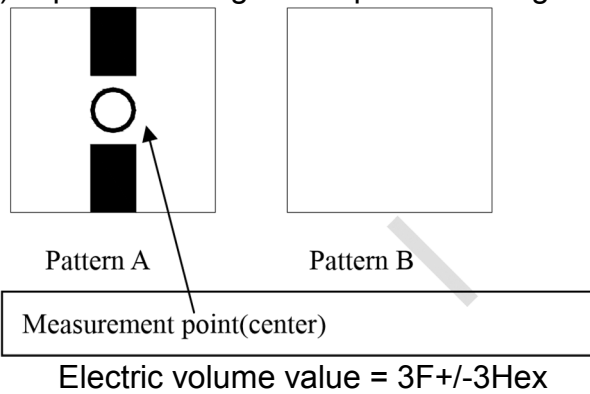



7.0 Reliability Test Condition

Item		Test Condition
Operating	High Temperature	70degC, 240 hrs
	Low Temperature	-20degC, 240 hrs
Storage	High Temperature	80degC, 240hrs and recovery for 2hrs
	Low Temperature	-30degC, 240hrs and recovery for 2hrs
	High Temperature and High Humidity	50degC, 90%RH, 240hrs and recovery for 2 hrs
Thermal	Cycle	RT → 20degC → Rt → 70degC → RT 0min 30min 5min 30min 5min 50 cycles (Power off)
	Shock	RT → 20degV → 70degC 0min 30min 30min 50 cycles (Power off)

Note: RT means Room temperature

8.0 Inspection Criteria

No	Defect	Definition of defect	Inspection Criteria														
1	a) Definition of dot	<p>The size of defective dot over 1/2 of whole is regards as one defective dot.</p> <p>Smaller than 1/2      Larger than 1/2</p> <p>'No dot defect' (ignore)      '1 dot defect' (counted)</p>	<p>A – Viewing area B – Viewing area C – Outside Viewing area</p>														
	b) Bright Dot	Dot appear bright and unchanged in size when LCD panel is displaying black pattern	<table border="1"> <tr> <th>Defect</th> <th>A</th> <th>B</th> <th>C</th> </tr> <tr> <td>Bright Dot</td> <td>1</td> <td>1</td> <td rowspan="3">NC</td> </tr> <tr> <td>Dark Dot</td> <td>2</td> <td>2</td> </tr> <tr> <td>Total</td> <td colspan="2">4</td> </tr> </table> <p>NC – Not Count</p>	Defect	A	B	C	Bright Dot	1	1	NC	Dark Dot	2	2	Total	4	
	Defect	A	B	C													
	Bright Dot	1	1	NC													
Dark Dot	2	2															
Total	4																
c) Dark Dot	Dot appear dark and unchanged in size when LCD panel is displaying pure color (RED, GREEN or BLUE) pattern	<table border="1"> <tr> <th>Defect</th> <th>A</th> <th>B</th> <th>C</th> </tr> <tr> <td>Bright Dot</td> <td>1</td> <td>1</td> <td rowspan="3">NC</td> </tr> <tr> <td>Dark Dot</td> <td>2</td> <td>2</td> </tr> <tr> <td>Total</td> <td colspan="2">4</td> </tr> </table> <p>NC – Not Count</p>	Defect	A	B	C	Bright Dot	1	1	NC	Dark Dot	2	2	Total	4		
Defect	A	B	C														
Bright Dot	1	1	NC														
Dark Dot	2	2															
Total	4																
d) 2 dot adjacent	<p>1 pair = 2 dots</p> <p>Type 1      Type 2</p> <p>or</p> <p>Type 3</p>	<table border="1"> <tr> <th>Defect</th> <th>Acc. Count</th> </tr> <tr> <td>2 Bright dot Adjacent</td> <td>0</td> </tr> <tr> <td>2 Dark dot Adjacent</td> <td>1</td> </tr> </table>	Defect	Acc. Count	2 Bright dot Adjacent	0	2 Dark dot Adjacent	1									
Defect	Acc. Count																
2 Bright dot Adjacent	0																
2 Dark dot Adjacent	1																
2	<p>Black spot White Spot Bright spot Pin Hole Foreign Particle</p>	<p>-Black/Dark/Bright Spot is points on display which appear dark/bright and usually result from contamination - These defect do not vary in size intensity (contrast) when kontras is varied.</p> <p><math>D=(a+b)/2(mm)</math></p>	<table border="1"> <tr> <th>Defect Category</th> <th>A</th> <th>B</th> </tr> <tr> <td><math>D \leq 0.10</math></td> <td>NC</td> <td rowspan="4">NC</td> </tr> <tr> <td><math>0.10 \leq D \leq 0.20</math></td> <td>2</td> </tr> <tr> <td><math>0.20 \leq D \leq 0.30</math></td> <td>1</td> </tr> <tr> <td><math>D \geq 0.30</math></td> <td>0</td> </tr> </table>	Defect Category	A	B	$D \leq 0.10$	NC	NC	$0.10 \leq D \leq 0.20$	2	$0.20 \leq D \leq 0.30$	1	$D \geq 0.30$	0		
Defect Category	A	B															
$D \leq 0.10$	NC	NC															
$0.10 \leq D \leq 0.20$	2																
$0.20 \leq D \leq 0.30$	1																
$D \geq 0.30$	0																
3	<p>Black Line White line Particle between POL and Glass Scratch on Glass</p>		<table border="1"> <tr> <th>Defect Category</th> <th>A</th> <th>B</th> </tr> <tr> <td><math>W \leq 0.03</math></td> <td>NC</td> <td rowspan="3">NC</td> </tr> <tr> <td><math>0.03 \leq W \leq 0.08, L \leq 2.0</math></td> <td>2</td> </tr> <tr> <td><math>W \geq 0.08</math></td> <td>0</td> </tr> </table>	Defect Category	A	B	$W \leq 0.03$	NC	NC	$0.03 \leq W \leq 0.08, L \leq 2.0$	2	$W \geq 0.08$	0				
Defect Category	A	B															
$W \leq 0.03$	NC	NC															
$0.03 \leq W \leq 0.08, L \leq 2.0$	2																
$W \geq 0.08$	0																
4	<p>POL Bubble POL Dented</p>		<table border="1"> <tr> <th>Defect Category</th> <th>A</th> <th>B</th> </tr> <tr> <td><math>D \leq 0.20</math></td> <td>NC</td> <td rowspan="4">NC</td> </tr> <tr> <td><math>0.20 \leq D \leq 0.30</math></td> <td>3</td> </tr> <tr> <td><math>0.30 \leq D \leq 0.50</math></td> <td>2</td> </tr> <tr> <td><math>D \geq 0.5</math></td> <td>0</td> </tr> </table>	Defect Category	A	B	$D \leq 0.20$	NC	NC	$0.20 \leq D \leq 0.30$	3	$0.30 \leq D \leq 0.50$	2	$D \geq 0.5$	0		
Defect Category	A	B															
$D \leq 0.20$	NC	NC															
$0.20 \leq D \leq 0.30$	3																
$0.30 \leq D \leq 0.50$	2																
$D \geq 0.5$	0																
5	<p>Mura (50% Grey)</p>		<p>Judged by Limit sample</p>														



## 9.0 Precaution and Limited Warranty

### 1. Handling Precautions

- a. The display panel is made of glass and polarizer. As glass is fragile. It tends to chip during handling especially on the edges. Please avoid dropping or jarring. Do not subject it to a mechanical shock of impact or by dropping it.
- b. If the display panel is damaged and the liquid crystal substance leaks out, be sure not to get any in your mouth. If the substance is in contact with your skin or clothes, wash it off using soap and water.
- c. Do not apply excessive force to the display surface or the adjoining areas since this may cause the color tone to vary. Do not touch the display with bare hands. This will stain the display area and degrade the insulation between terminals. Scratch and dents may occur on polarizer too.
- d. The polarizer covering the display surface of the LCD module is soft and easily scratched. Handle this polarizer carefully. Do not touch, push or rub the exposed polarizers with anything harder than a HB pencil lead (glass, tweezers, etc.). Do not put or attach anything on the display area to avoid leaving marks on it. Condensation on the surface and contact with terminals due to cold will damage, stain or dirty the polarizer. After products are tested at low temperature they must be warmed up in a container before coming in to contact with room temperature air.
- e. If the display surface becomes contaminated, breathe on the surface and gently wipe it with a soft dry cloth. If it is heavily contaminated, moisten cloth with one of the following solvents
  - Isopropyl alcohol
  - Ethyl alcohol
  - Do not scrub hard to avoid damaging the display surface.
- f. Solvents other than those above-mentioned may damage the polarizer. Especially, do not use the following.
  - Water
  - Ketone
  - Aromatic solvents
  - Wipe off saliva or water drops immediately, contact with water over a long period of time may cause deformation or color fading. Avoid contact with oil and fats.
- g. Exercise care to minimize corrosion of the electrode. Corrosion of the electrodes is accelerated by water droplets, moisture condensation or a current flow in a high-humidity environment.
- h. Install the LCD Module by using the mounting holes. When mounting the LCD module make sure it is free of twisting, warping and distortion. In particular, do not forcibly pull or bend the I/O cable or the backlight cable.
- i. Do not attempt to disassemble or process the LCD module.
- j. NC terminal should be open. Do not connect anything.
- k. If the logic circuit power is off, do not apply the input signals.
- l. Electro-Static Discharge Control. Since this module uses a CMOS LSI, the same careful attention should be paid to electrostatic discharge as for an ordinary CMOS IC. To prevent destruction of the elements by static electricity, be careful to maintain an optimum work environment.
  - Before removing LCM from its packing case or incorporating it into a set, be sure the module and your body have the same electric potential. Be sure to ground the body when handling the LCD modules.
  - Tools required for assembly, such as soldering irons, must be properly grounded. Make certain the AC power source for the soldering iron does not leak. When using an electric screwdriver to attach LCM, the screw driver should be of ground potentiality to minimize as much as possible any



transmission of electromagnetic waves produced sparks coming from the commutator of the motor.

- To reduce the amount of static electricity generated, do not conduct assembly and other work under dry conditions. To reduce the generation of static electricity be careful that the air in the work environment is not too dry. A relative humidity of 50%-60% is recommended. As far as possible make the electric potential of your work clothes and that of the work bench the ground potential.
  - The LCD module is coated with a film to protect the display surface. Exercise care when peeling off this protective film since static electricity may be generated.
- m. Since LCM has been assembled and adjusted with a high degree of precision, avoid applying excessive shocks to the module or making any alterations or modifications to it.
- Do not alter, modify or change the shape of the tab on the metal frame.
  - Do not make extra holes on the printed circuit board, modify its shape or change the positions of components to be attached.
  - Do not damage or modify the pattern writing on the printed circuit board.
  - Absolutely do not modify the zebra rubber strip (conductive rubber) or heat seal connector.
  - Except for soldering the interface, do not make any alterations or modifications with a soldering iron.
  - Do not drop, bend or twist the LCM.

## 2. Storage Precautions

When storing the LCD modules, the following precaution are necessary.

- a. Store them in a sealed polyethylene bag. If properly sealed, there is no need for the desiccant.
- b. Store them in a dark place. Do not expose to sunlight or fluorescent light, keep the temperature between 0°C and 35°C, and keep the relative humidity between 40%RH and 60%RH.
- c. The polarizer surface should not come in contact with any other objects.

## 3. Others

- a. Liquid crystals solidify under low temperature (below the storage temperature range) leading to defective orientation or the generation of air bubbles (black or white). Air bubbles may also be generated if the module is subject to a low temperature.
- b. If the LCD modules have been operating for a long time showing the same display patterns, the display patterns may remain on the screen as ghost images and a slight contrast irregularity may also appear. A normal operating status can be regained by suspending use for some time. It should be noted that this phenomenon does not adversely affect performance reliability.
- c. To minimize the performance degradation of the LCD modules resulting from destruction caused by static electricity etc. Exercise care to avoid holding the following sections when handling the modules.
  - Exposed area of the printed circuit board.
  - Terminal electrode sections.

## 4. Using LCD Modules

### a. Installing LCD Modules

The hole in the printed circuit board is used to fix LCM as shown in the picture below.

Attend to the following items when installing the LCM.

- b. Cover the surface with a transparent protective plate to protect the polarizer and LC cell.

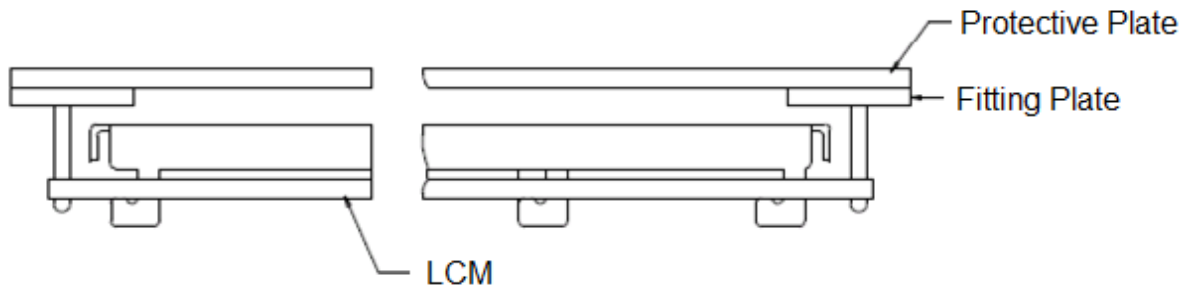

- c. When assembling the LCM into other equipment, the spacer to the bit between the LCM and the fitting plate should have enough height to avoid causing stress to the module surface, refer to the individual specifications for measurements. The measurement tolerance should be 0.1mm.
- d. Precaution for assemble the module with BTB connector:  
Please note the position of the male and female connector position, don't assemble or assemble like the method which the following picture shows

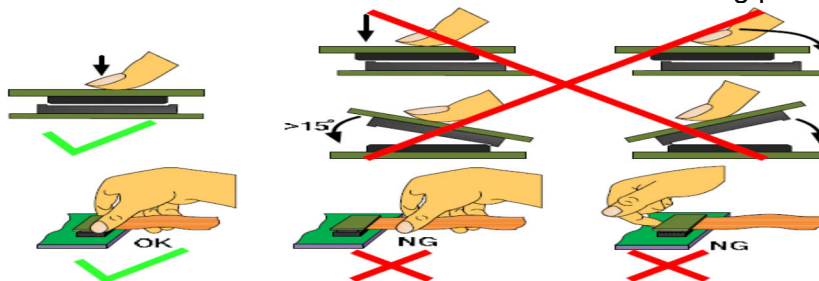

5. Precaution for soldering the LCM

	Manual soldering	Machine drag soldering	Machine press soldering
No RoHS Product	290°C ~350°C. Time: 3-5S.	330°C ~350°C. Speed: 4-8 mm/s.	300°C ~330°C. Time: 3-6S. Press: 0.8~1.2Mpa
RoHS Product	340°C ~370°C. Time: 3-5S.	350°C ~370°C. Time: 4-8 mm/s.	330°C ~360°C. Time: 3-6S. Press: 0.8~1.2Mpa

- a. If soldering flux is used, be sure to remove any remaining flux after finishing the soldering operation (This does not apply in the case of a non-halogen type of flux). It is recommended that you protect the LCD surface with a cover during soldering to prevent any damage due to flux spatters.
- b. When soldering the electroluminescent panel and PC board, the panel and board should not be detached more than three times. This maximum number is determined by the temperature and time conditions mentioned above, though there may be some variance depending on the temperature of the soldering iron.
- c. When removing the electroluminescent panel from the PC board, be sure the solder has completely melted, the soldered pad on the PC board could be damaged.

6. Precautions for Operation

- a. Viewing angle varies with the change of liquid crystal driving voltage (VLCD).  
Adjust VLCD to show the best contrast.





- b. It is recommended to drive LCD's within the specified voltage limit since over limit will cause shorter LCD life. An electrochemical reaction due to direct current causes LCD-deterioration. Avoid the use of direct current drive.
- c. Response time will be extremely delayed at lower temperature compared to room operating temperature range and on the other hand, at higher temperature LCD shows dark color in them. However those phenomena do not mean malfunction. The LCD will return to normal performance when ambient temperature revert to room condition.
- d. If the display area is pushed hard during operation, the display will become abnormal. However, it will return to normal if it is turned off and on.
- e. A slight dew depositing on terminals is a cause for electro-chemical reaction resulting in terminal open circuit.
- f. Input logic voltage before apply analogue high voltage such as LCD driving voltage when power on. Remove analogue high voltage before logic voltage when power off the module. Input each signal after the positive/negative voltage becomes stable.
- g. Please keep the temperature within the specified range for use and storage. Polarization degradation, bubble generation or polarizer peel-off may occur with high temperature and high humidity.

**7. Safety**

- a. It is recommended to crush damaged or unnecessary LCDs into pieces and wash them off with solvents such as acetone and ethanol, which should later be burned.
- b. If any liquid leaks out of a damaged glass cell and comes in contact with the hands, wash off thoroughly with soap and water.

**8. Limited Warranty**

Unless otherwise agreed between Crystal Clear Technology and customer, Crystal Clear Technology will replace or repair any of its LCD and LCM which is found to be defective electrically and visually when inspected in accordance with Crystal Clear Technology acceptance standards, for a period of one year from date of shipment. Confirmation of such date shall be based on freight documents. The warranty liability of Crystal Clear Technology is limited to repair and/or replacement on the terms set forth above. Crystal Clear Technology will not responsible for any subsequent or consequential events.

**9. Return LCM under Warranty**

No warranty can be granted if the precautions stated above have been disregarded. The typical examples of violations are:

- Broken LCD glass
- PCB eyelet's damaged or modified
- PCB conductors damaged
- Circuit modified in any way, including addition of components.
- PCB tampered with by grinding, engraving or painting varnish.
- Soldering to, or modifying the bezel in any manner.

Module repairs will be invoiced to customer upon mutual agreement. Modules must be returned with sufficient description of failure or defects. Any connectors or cable installed by customer must be removed completely without damaging the PCB eyelet's, conductors and terminals.

