

CRYSTAL CLEAR TECHNOLOGY

Product Specification

T240B01X00

(Formally known as T240B01W00)

(REVISION 4)

Crystal Clear Technology Sdn. Bhd.

16 Jalan TP5, Taman Perindustrian Sime UEP,

47600 Subang Jaya, Selangor DE

Tel: +603-80247099

Website: www.cct.com.my



Record of revision

Rev	Date	Item	Page	Comment	Originator	Checked By
1.0	04/12/2014			Initial Release	WHong	Liew
2.0	26/10/2015			Change model name		
				Revise Drawing	Azhar	Azhar
3.0	28/06/2016			Add Precaution	Azhar	Azhar
4.0	09/02/2017			Update		
				Reliability Test Condition		
				Inspection Standard		
				Precaution / limited Warranty	Azhar	Azhar

**Note: The product and specifications are subject to change without any notice.
Please ask for the latest Product Standards to guarantee the satisfaction of our product requirements.**



1.0 General Information

Item	Contents	Unit	Note
LCD Type	TFT	-	
Display color	262k		1
Viewing Direction (Optimum View)	6	O'Clock	
Operating temperature	-20~+70	°C	
Storage temperature	-30~+80	°C	
Module size	42.72(W) x 60.26(L) x 2.46(H)	mm	2
Active Area(W×H)	36.72 x 48.96	mm	
Number of Dots	240 (RGB) x 320	dots	
Power Supply Voltage	2.8	V	
Backlight	4 White leds	pcs	
Brightness	200	cd/m2	
Interface	8080 – 8 Bit Parallel	-	

Note 1: Colour tone is slightly changed by temperature and driving voltage.

Note 2: Refer to Mechanical drawing for detail dimension.



2. Electrical Characteristic

2.1 Electrical Absolute Maximum Ratings.(V_{ss}=0V ,T_a=25°C)

No	ITEM	SYMBOL	RATING	UNIT
1	Supply Voltage	VDD	-0.3 ~ +4.6	V
2	Supply Voltage (Logic)	VDDI	-0.3 ~ +4.6	V
3	Driver Supply Voltage	VGH – VGL	-0.3 ~ +30.0	V
4	Logic Input Voltage Range	VIN	-0.3 ~ VDDI + 0.5	V
5	Logic Output Voltage Range	VO	-0.3 ~ VDDI + 0.5	V

Notes:

1. If the module is above these absolute maximum ratings. It may become permanently damaged. Using the module within the following electrical characteristic conditions are also exceeded, the module will malfunction and cause poor reliability.
2. Please be sure users are grounded when handling LCD Module.

2.2 Environmental Absolute Maximum Ratings.

Item	Storage		Operating		Note
	MIN.	MAX.	MIN.	MAX.	
Ambient Temperature	-30°C	80°C	-20°C	70°C	1,2
Humidity	-	-	-	-	3

1. The response time will become lower when operated at low temperature.
2. Background color changes slightly depending on ambient temperature.
The phenomenon is reversible.
3. T_a≤40°C:85 %RH MAX.
T_a>40°C: Absolute humidity must be lower than the humidity of 85%RH at 40°C.

2.3 Electrical Characteristic (V_{SS} = 0V, T_a = 25°C)

NO	ITEM	SYMBOL	CONDITION	MIN	TYP	MAX	UNIT
1.	System Voltage	VDD	Operating voltage	2.4	2.75	3.3	V
2.	Interface Operation Voltage	VDDI	I/O Supply Voltage	1.65	1.8	3.3	V
3.	Gate Driver High Voltage	VGH		12.2	-	14.97	V
4.	Gate Driver Low Voltage	VGL		- 12.5	-	- 7.16	V
5.	Gate Driver Supply Voltage		VGH-VGL	19.36	-	27.47	V
6.	Logic-High Input Voltage	VIH		0.7VDDI	-	VDDI	V
7.	Logic-Low Input Voltage	VIL		VSS	-	0.3VDDI	V
8.	Logic-High Output Voltage	VOH	IOH = -1.0mA	0.8VDDI	-	VDDI	V
9.	Logic-Low Output Voltage	VOL	IOL = +1.0mA	VSS	-	0.2VDDI	V
10.	Logic-High Input Current	IIH	VIN = VDDI	-	-	1	uA
11.	Logic-Low Input Current	IIL	VIN = VSS	- 1	-	-	uA
12.	Input Leakage Current	IIL	IOH = -1.0mA	- 0.1	-	+ 0.1	uA

Note:

- 1: When an optimum contrast is obtained in transmissive mode.
- 2: Tested in 1x1 chessboard pattern.

3. Backlight Characteristic

NO	COLOR	FORWARD VOLTAGE (V)			FORWARD CURRENT (mA)		
		Min	Typ.	Max	Min	Typ.	Max
1.	White	-	3.3	-	-	20x4	25x4

- *Note: 1. On LCD surface, brightness is only about 5% to 10% of backlight brightness.
 2. Lifetime of White backlight is about 10K hrs (T_a = 25°C)
 * A LED drive in constant current mode is recommended.

4. Mechanical Specification

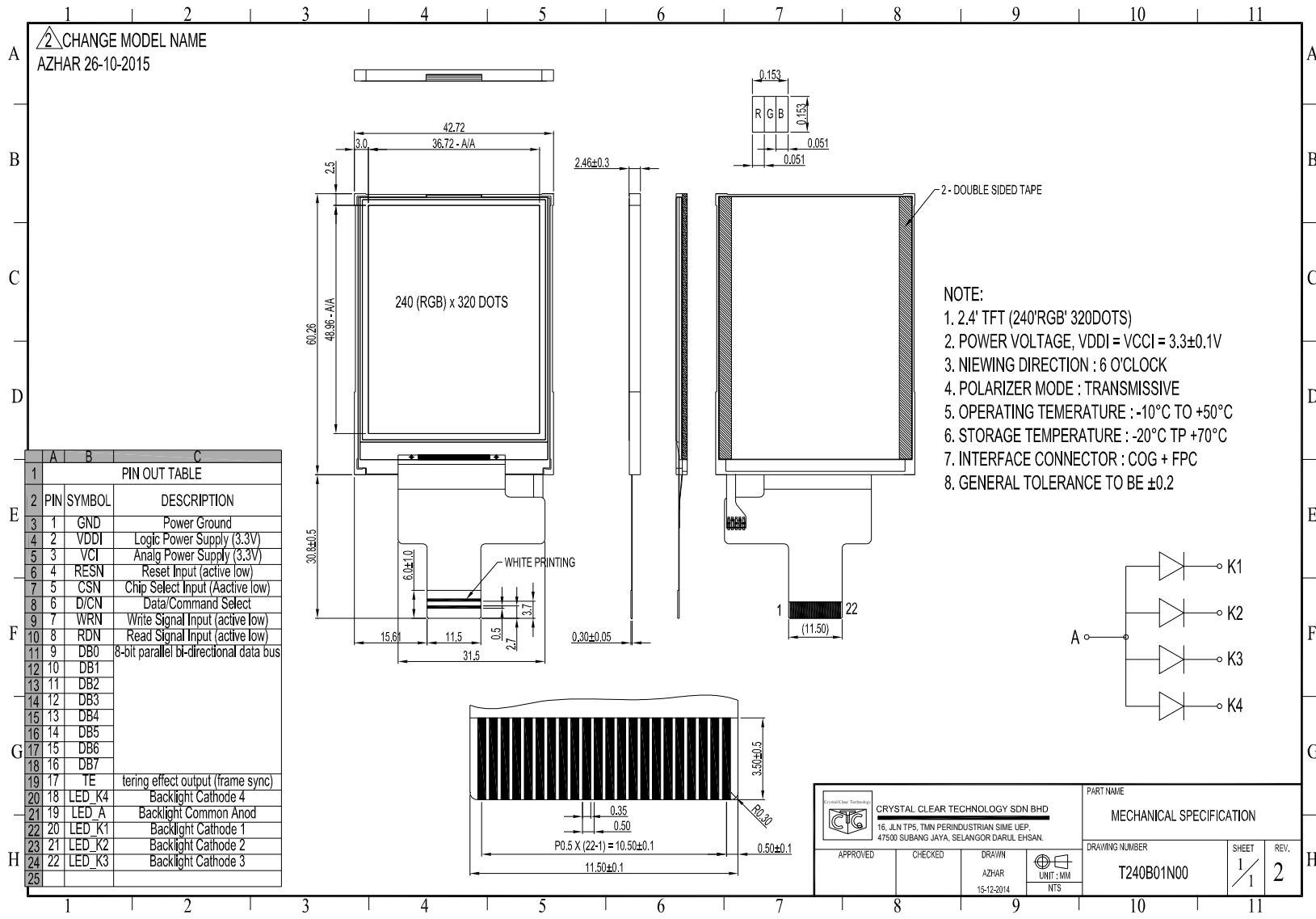



5. Interface Description

Pin No.	Symbol	Function
1	GND	Ground
2	VDDI	Power supply for IO system
3	VCI	Power supply for analog and booster circuit
4	RESN	Reset input, active low
5	CSN	Chip select input, active low
6	DCN	Register select input, H : Data / Parameter, L : Command
7	WRN	Write Enable Clock Input
8	RDN	Read Enable Clock Input
9	DB0	8 bits bi-directional data bus
10	DB1	8 bits bi-directional data bus
11	DB2	8 bits bi-directional data bus
12	DB3	8 bits bi-directional data bus
13	DB4	8 bits bi-directional data bus
14	DB5	8 bits bi-directional data bus
15	DB6	8 bits bi-directional data bus
16	DB7	8 bits bi-directional data bus
17	TE	Tearing effect signal is used to synchronize MCU to frame memory writing.
18	GND	Ground
19	LED_A	LED anode
20	LED_K1	LED cathode 1
21	LED_K2	LED cathode 2
22	LED_K3	LED cathode 3



6. Optical Characteristic

Item	Symbol	Conditions	Specifications			Unit	Note
			Min.	Typ.	Max.		
Brightness	Lv	Viewing normal angle X = 0, Y = 0	200	-	-	cd/m2	All left side data are based on CMI's following condition – 1.LC : TN 2.Light Source :CMI LED BLU 3.Film :NPF TEG 1465DU 4.Machine : DMS 803
Contrast Ratio	CR		-	250	-		
Response Time (by Quick)	Ton + Toff		-	30	-	ms	
Viewing Angle	Hor.	X+	-	45	-	deg.	
		X-	-	45	-		
	Ver.	Y+	-	45	-		
		Y-	-	20	-		
CF only Color Chromaticity (CIE 1931)	Red	X _R	0.592	0.612	0.632	1. Under C light Simulation 2. NTSC 56%	
		Y _R	0.309	0.329	0.349		
	Green	X _G	0.279	0.299	0.319		
		Y _G	0.547	0.567	0.587		
	Blue	X _B	0.124	0.144	0.164		
		Y _B	0.090	0.110	0.130		
	White	X _W	0.288	0.308	0.328		
		Y _W	0.305	0.325	0.345		

*Note (1) Definition of Contrast Ratio (CR):

The contrast ratio can be calculated by the following expression.

$$\text{Contrast Ratio (CR)} = L63 / L0$$

L63: Luminance of grey level 63 L 0: Luminance of grey level 0 CR = CR (5)

CR (X) is corresponding to the Contrast Ratio of the point X at Figure in Note (5).

*Note (2) Definition of Response Time (T_{on}, T_{off}):

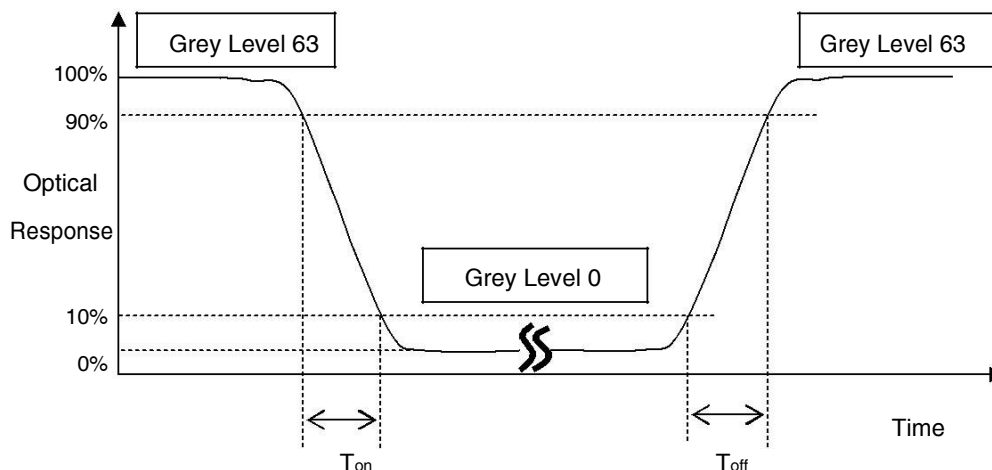



*Note (3) Definition of Viewing Angle

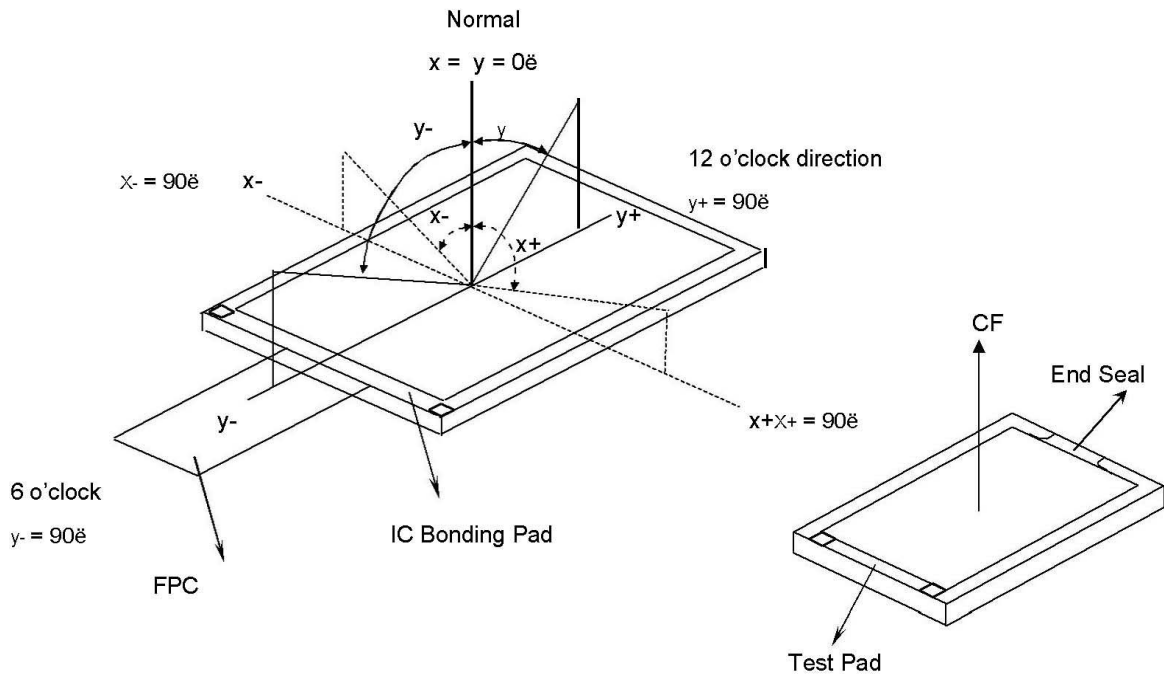

*Note (4) Measurement Set-Up:

The LCD module should be stabilized at a given temperature for 20 minutes to avoid abrupt temperature change during measuring. In order to stabilize the luminance, the measurement should be executed after lighting Backlight for 20 minutes in a windless room.

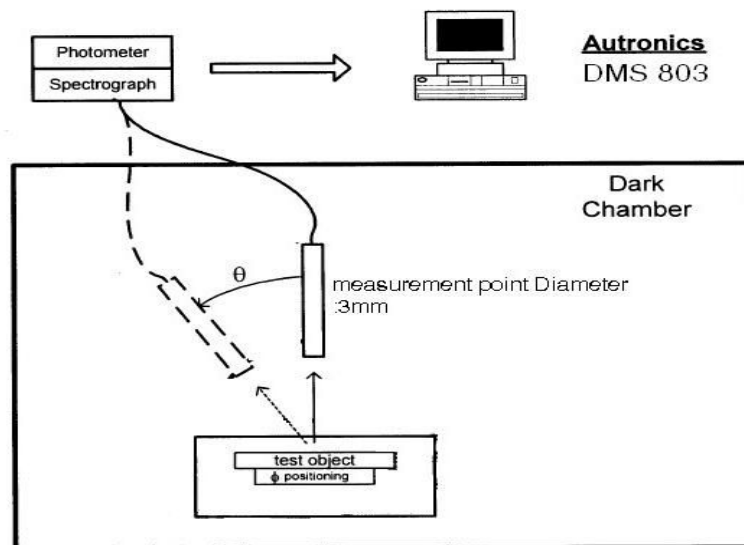



*Note (5)

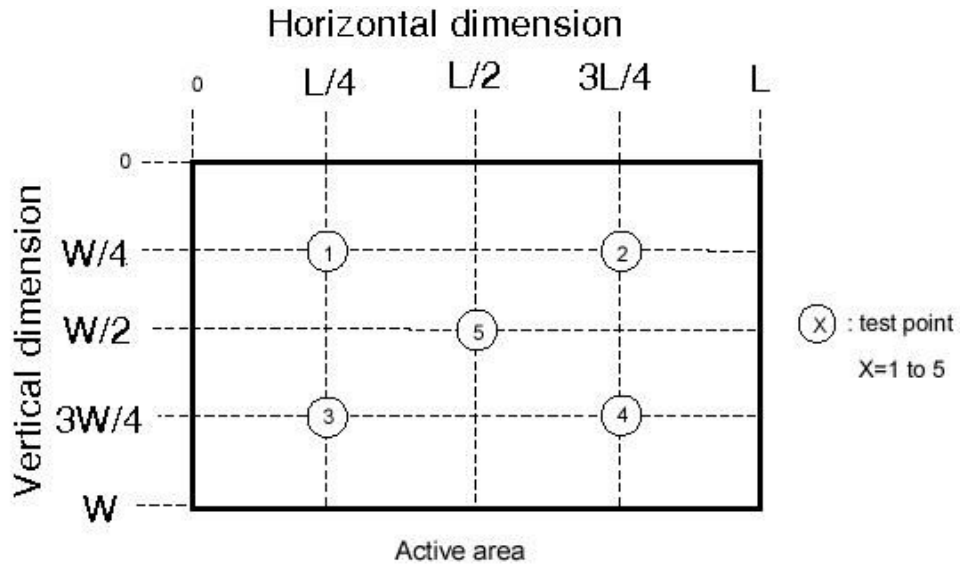

Note 6: Definition of contrast ratio.(Test LCD using DMS501)

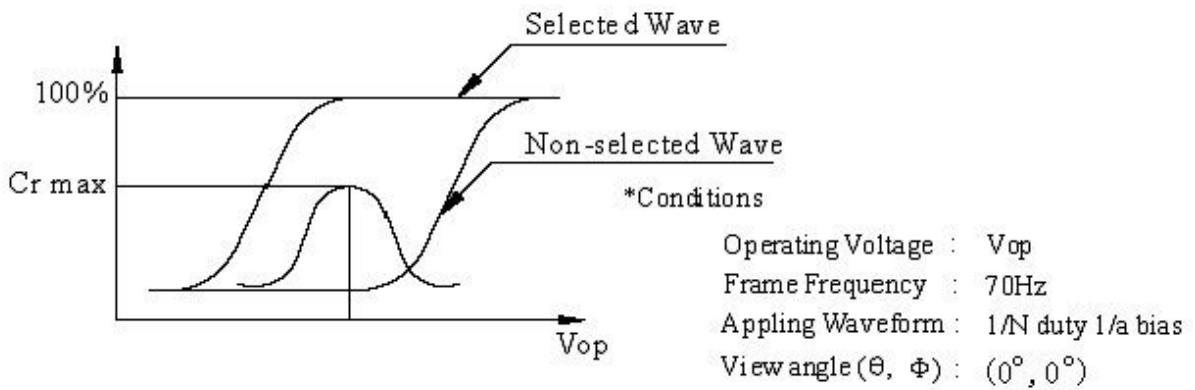

$$\text{Contrast ratio (Cr)} = \frac{\text{Brightness of selected dots}}{\text{Brightness of non-selected dots}}$$



Note 7: Definition of Colour of CIE Coordinate and NTSC Ratio.

Colour gamut: area of RGB triangle S = $\frac{\text{area of RGB triangle}}{\text{area of NTSC triangle}} \times 100 \%$

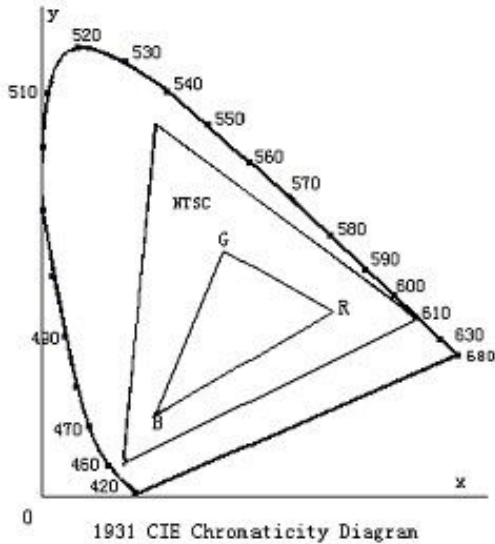

Note 8: Definition of cross talk.

Cross talk ratio (%) = $\frac{\text{pattern A Brightness} - \text{pattern B Brightness}}{\text{pattern A Brightness}} \times 100$

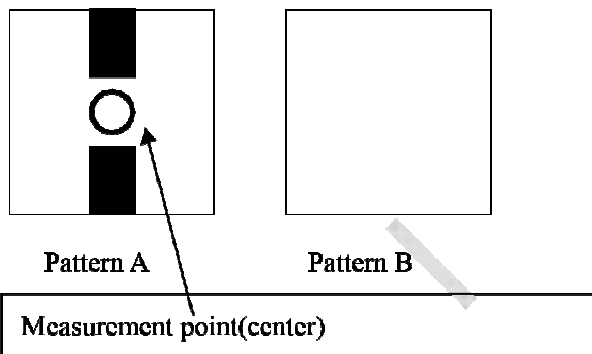

Electric volume value=3F+/-3Hex



7. Reliability Test Condition and methods

NO	ITEM	CONDITION	
1.	High Temperature Storage	+80±2°C / 96Hours	Inspection after 2 ~ 4 hours storage at room temperature, the sample shall be free from defects: 1. Air bubble in LCD 2. Seal leak 3. Non-Display 4. Missing segment 5. Glass crack 6. Current Idd should be lower than double of initial Idd.
2.	Low Temperature Storage	-30±2°C / 96Hours	
3	High Temperature Operating	+70±2°C / 96Hours	
4	Low Temperature Operating	-20±2°C / 96Hours	
5	Temperature Cycle Operating	-20±2°C ~ 25°C ~ +70±°C x 10 Cycles	
6	Humidity Test (Operating)	40°C, 90±5%RH, 96Hrs	

Note:

1. The background on LCD has the possibility to be changed in different temperature range.
2. The test samples should be applied to only one test item.
3. Sample size for each test item is 1 ~ 5 pcs.

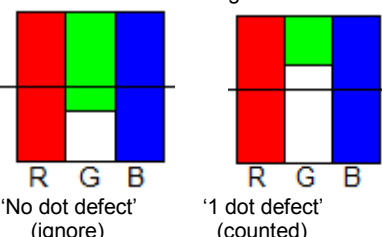
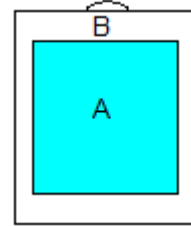
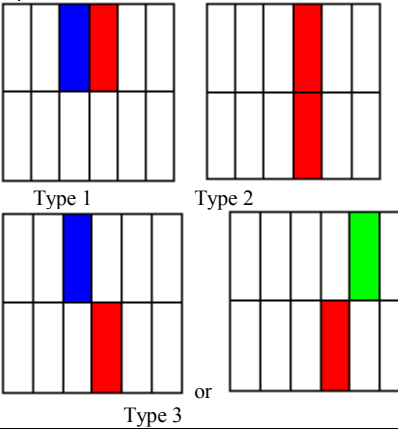
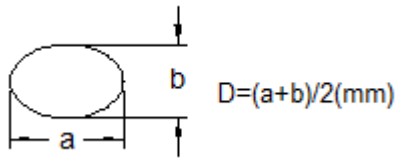
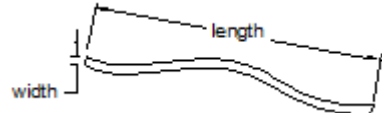

8. Inspection Standard

No	Defect	Definition of defect	Inspection Criteria											
1	a) Definition of dot	<p>The size of defective dot over 1/2 of whole is regards as one defective dot.</p> <p>Smaller than 1/2 Larger than 1/2</p>  <p>'No dot defect' (ignore) '1 dot defect' (counted)</p>	<p>A – Viewing Area B – Outside viewing area</p> 											
	b) Bright Dot	Dot appear bright and unchanged in size when LCD panel is displaying black pattern	<table border="1"> <tr> <th>Defect</th> <th>A</th> <th>B</th> </tr> <tr> <td>Bright Dot</td> <td>1</td> <td rowspan="3">NC</td> </tr> <tr> <td>Dark Dot</td> <td>2</td> </tr> <tr> <td>Total</td> <td>3</td> </tr> </table> <p>NC – Not Count</p>	Defect	A	B	Bright Dot	1	NC	Dark Dot	2	Total	3	
	Defect	A		B										
	Bright Dot	1	NC											
Dark Dot	2													
Total	3													
c) Dark Dot	Dot appear dark and unchanged in size when LCD panel is displaying pure color (RED, GREEN or BLUE) pattern													
d) 2 dot adjacent	<p>1 pair = 2 dots</p>  <p>Type 1 Type 2</p> <p>Type 3</p>	<table border="1"> <tr> <th>Defect</th> <th>Acc. Count</th> </tr> <tr> <td>2 Bright dot Adjacent</td> <td>0</td> </tr> <tr> <td>2 Dark dot Adjacent</td> <td>1</td> </tr> </table>	Defect	Acc. Count	2 Bright dot Adjacent	0	2 Dark dot Adjacent	1						
Defect	Acc. Count													
2 Bright dot Adjacent	0													
2 Dark dot Adjacent	1													
2	<p>Black spot White Spot Bright spot Pin Hole Foreign Particle</p> <p>-Black/Dark/Bright Spot is points on display which appear dark/bright and usually result from contamination - These defect do not vary in size intensity (contrast) when kontras is varied.</p>  <p>$D = (a+b)/2(\text{mm})$</p>	<table border="1"> <tr> <th>Defect Category</th> <th>A</th> <th>B</th> </tr> <tr> <td>$D \leq 0.10$</td> <td>NC</td> <td rowspan="4">NC</td> </tr> <tr> <td>$0.10 \leq D \leq 0.15$</td> <td>2</td> </tr> <tr> <td>$0.15 \leq D \leq 0.20$</td> <td>1</td> </tr> <tr> <td>$D \geq 0.2$</td> <td>0</td> </tr> </table>	Defect Category	A	B	$D \leq 0.10$	NC	NC	$0.10 \leq D \leq 0.15$	2	$0.15 \leq D \leq 0.20$	1	$D \geq 0.2$	0
Defect Category	A	B												
$D \leq 0.10$	NC	NC												
$0.10 \leq D \leq 0.15$	2													
$0.15 \leq D \leq 0.20$	1													
$D \geq 0.2$	0													
3	<p>Black Line White line Particle between POL and Glass Scratch on Glass</p>  <p>width length</p>	<table border="1"> <tr> <th>Defect Category</th> <th>A</th> <th>B</th> </tr> <tr> <td>$W \leq 0.03$</td> <td>NC</td> <td rowspan="3">NC</td> </tr> <tr> <td>$0.03 \leq W \leq 0.05, L \leq 2.0$</td> <td>2</td> </tr> <tr> <td>$W \geq 0.05$</td> <td>0</td> </tr> </table>	Defect Category	A	B	$W \leq 0.03$	NC	NC	$0.03 \leq W \leq 0.05, L \leq 2.0$	2	$W \geq 0.05$	0		
Defect Category	A	B												
$W \leq 0.03$	NC	NC												
$0.03 \leq W \leq 0.05, L \leq 2.0$	2													
$W \geq 0.05$	0													
4	<p>POL Bubble POL Dented</p>	<table border="1"> <tr> <th>Defect Category</th> <th>A</th> <th>B</th> </tr> <tr> <td>$D \leq 0.20$</td> <td>NC</td> <td rowspan="4">NC</td> </tr> <tr> <td>$0.20 \leq D \leq 0.30$</td> <td>3</td> </tr> <tr> <td>$0.30 \leq D \leq 0.50$</td> <td>2</td> </tr> <tr> <td>$D \geq 0.5$</td> <td>0</td> </tr> </table>	Defect Category	A	B	$D \leq 0.20$	NC	NC	$0.20 \leq D \leq 0.30$	3	$0.30 \leq D \leq 0.50$	2	$D \geq 0.5$	0
Defect Category	A	B												
$D \leq 0.20$	NC	NC												
$0.20 \leq D \leq 0.30$	3													
$0.30 \leq D \leq 0.50$	2													
$D \geq 0.5$	0													
5	<p>Mura (50% Grey)</p>	<p>Judged by Limit sample</p>												



9. PRECAUTION FOR USING LCM

1. Handling Precautions

- a. The display panel is made of glass and polarizer. As glass is fragile. It tends to chip during handling especially on the edges. Please avoid dropping or jarring. Do not subject it to a mechanical shock of impact or by dropping it.
- b. If the display panel is damaged and the liquid crystal substance leaks out, be sure not to get any in your mouth. If the substance is in contact with your skin or clothes, wash it off using soap and water.
- c. Do not apply excessive force to the display surface or the adjoining areas since this may cause the colour tone to vary. Do not touch the display with bare hands. This will stain the display area and degrade the insulation between terminals. Scratch and dents may occur on polarizer too.
- d. The polarizer covering the display surface of the LCD module is soft and easily scratched. Handle this polarizer carefully. Do not touch, push or rub the exposed polarizers with anything harder than a HB pencil lead (glass, tweezers, etc.). Do not put or attach anything on the display area to avoid leaving marks on it. Condensation on the surface and contact with terminals due to cold will damage, stain or dirty the polarizer. After products are tested at low temperature they must be warmed up in a container before coming in to contact with room temperature air.
- e. If the display surface becomes contaminated, breathe on the surface and gently wipe it with a soft dry cloth. If it is heavily contaminated, moisten cloth with one of the following solvents
 - Isopropyl alcohol
 - Ethyl alcohol
 - Do not scrub hard to avoid damaging the display surface.
- f. Solvents other than those above-mentioned may damage the polarizer. Especially, do not use the following.
 - Water
 - Ketone
 - Aromatic solvents
 - Wipe off saliva or water drops immediately, contact with water over a long period of time may cause deformation or colour fading. Avoid contact with oil and fats.
- g. Exercise care to minimize corrosion of the electrode. Corrosion of the electrodes is accelerated by water droplets, moisture condensation or a current flow in a high-humidity environment.
- h. Install the LCD Module by using the mounting holes. When mounting the LCD module make sure it is free of twisting, warping and distortion. In particular, do not forcibly pull or bend the I/O cable or the backlight cable.
- i. Do not attempt to disassemble or process the LCD module.
- j. NC terminal should be open. Do not connect anything.
- k. If the logic circuit power is off, do not apply the input signals.
- l. Electro-Static Discharge Control. Since this module uses a CMOS LSI, the same careful attention should be paid to electrostatic discharge as for an ordinary CMOS IC. To prevent destruction of the elements by static electricity, be careful to maintain an optimum work environment.



- Before removing LCM from its packing case or incorporating it into a set, be sure the module and your body have the same electric potential. Be sure to ground the body when handling the LCD modules.
 - Tools required for assembly, such as soldering irons, must be properly grounded. Make certain the AC power source for the soldering iron does not leak. When using an electric screwdriver to attach LCM, the screw driver should be of ground potentiality to minimize as much as possible any transmission of electromagnetic waves produced sparks coming from the commutator of the motor.
 - To reduce the amount of static electricity generated, do not conduct assembly and other work under dry conditions. To reduce the generation of static electricity be careful that the air in the work environment is not too dry. A relative humidity of 50%-60% is recommended. As far as possible make the electric potential of your work clothes and that of the work bench the ground potential.
 - The LCD module is coated with a film to protect the display surface. Exercise care when peeling off this protective film since static electricity may be generated.
- m. Since LCM has been assembled and adjusted with a high degree of precision, avoid applying excessive shocks to the module or making any alterations or modifications to it.
- Do not alter, modify or change the shape of the tab on the metal frame.
 - Do not make extra holes on the printed circuit board, modify its shape or change the positions of components to be attached.
 - Do not damage or modify the pattern writing on the printed circuit board.
 - Absolutely do not modify the zebra rubber strip (conductive rubber) or heat seal connector.
 - Except for soldering the interface, do not make any alterations or modifications with a soldering iron.
 - Do not drop, bend or twist the LCM.

2. Storage Precautions

When storing the LCD modules, the following precaution are necessary.

- a. Store them in a sealed polyethylene bag. If properly sealed, there is no need for the desiccant.
- b. Store them in a dark place. Do not expose to sunlight or fluorescent light, keep the temperature between 0°C and 35°C, and keep the relative humidity between 40%RH and 60%RH.
- c. The polarizer surface should not come in contact with any other objects.

3. Others

- a. Liquid crystals solidify under low temperature (below the storage temperature range) leading to defective orientation or the generation of air bubbles (black or white). Air bubbles may also be generated if the module is subject to a low temperature.
- b. If the LCD modules have been operating for a long time showing the same display patterns, the display patterns may remain on the screen as ghost

images and a slight contrast irregularity may also appear. A normal operating status can be regained by suspending use for some time. It should be noted that this phenomenon does not adversely affect performance reliability.

- c. To minimize the performance degradation of the LCD modules resulting from destruction caused by static electricity etc. Exercise care to avoid holding the following sections when handling the modules.

- Exposed area of the printed circuit board.
- Terminal electrode sections.

4. Using LCD Modules

a. Installing LCD Modules

The hole in the printed circuit board is used to fix LCM as shown in the picture below.

Attend to the following items when installing the LCM.

- b. Cover the surface with a transparent protective plate to protect the polarizer and LC cell.

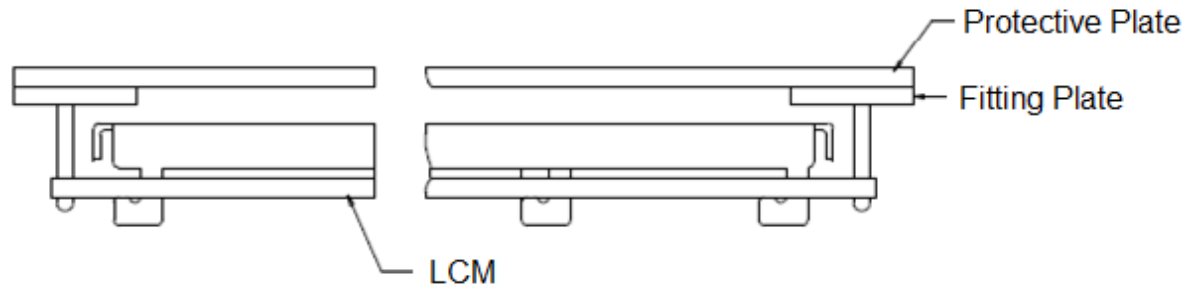

- c. When assembling the LCM into other equipment, the spacer to the bit between the LCM and the fitting plate should have enough height to avoid causing stress to the module surface, refer to the individual specifications for measurements. The measurement tolerance should be 0.1mm.

d. Precaution for assemble the module with BTB connector:

Please note the position of the male and female connector position, don't assemble or assemble like the method which the following picture shows

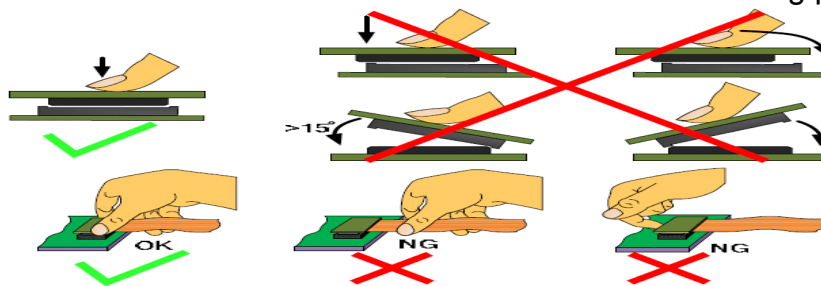

5. Precaution for soldering the LCM

	Manual soldering	Machine drag soldering	Machine press soldering
No RoHS Product	290°C ~350°C. Time: 3-5S.	330°C ~350°C. Speed: 4-8 mm/s.	300°C ~330°C. Time: 3-6S. Press: 0.8~1.2Mpa
RoHS Product	340°C ~370°C. Time: 3-5S.	350°C ~370°C. Time: 4-8 mm/s.	330°C ~360°C. Time: 3-6S. Press: 0.8~1.2Mpa



- a. If soldering flux is used, be sure to remove any remaining flux after finishing the soldering operation (This does not apply in the case of a non-halogen type of flux). It is recommended that you protect the LCD surface with a cover during soldering to prevent any damage due to flux spatters.
 - b. When soldering the electroluminescent panel and PC board, the panel and board should not be detached more than three times. This maximum number is determined by the temperature and time conditions mentioned above, though there may be some variance depending on the temperature of the soldering iron.
 - c. When removing the electroluminescent panel from the PC board, be sure the solder has completely melted, the soldered pad on the PC board could be damaged.
6. Precautions for Operation
- a. Viewing angle varies with the change of liquid crystal driving voltage (VLCD). Adjust VLCD to show the best contrast.
 - b. It is recommended to drive LCD's within the specified voltage limit since over limit will cause shorter LCD life. An electrochemical reaction due to direct current causes LCD-deterioration. Avoid the use of direct current drive.
 - c. Response time will be extremely delayed at lower temperature compared to room operating temperature range and on the other hand, at higher temperature LCD-shows dark colour in them. However those phenomena do not mean malfunction. The LCD will return to normal performance when ambient temperature revert to room condition.
 - d. If the display area is pushed hard during operation, the display will become abnormal. However, it will return to normal if it is turned off and on.
 - e. A slight dew depositing on terminals is a cause for electro-chemical reaction resulting in terminal open circuit.
 - f. Input logic voltage before apply analogue high voltage such as LCD driving voltage when power on. Remove analogue high voltage before logic voltage when power off the module. Input each signal after the positive/negative voltage becomes stable.
 - g. Please keep the temperature within the specified range for use and storage. Polarization degradation, bubble generation or polarizer peel-off may occur with high temperature and high humidity.
7. Safety
- a. It is recommended to crush damaged or unnecessary LCDs into pieces and wash them off with solvents such as acetone and ethanol, which should later be burned.
 - b. If any liquid leaks out of a damaged glass cell and comes in contact with the hands, wash off thoroughly with soap and water.



8. Limited Warranty

Unless otherwise agreed between Crystal Clear Technology and customer, Crystal Clear Technology will replace or repair any of its LCD and LCM which is found to be defective electrically and visually when inspected in accordance with Crystal Clear Technology acceptance standards, for a period of one year from date of shipment. Confirmation of such date shall be based on freight documents. The warranty liability of Crystal Clear Technology is limited to repair and/or replacement on the terms set forth above. Crystal Clear Technology will not responsible for any subsequent or consequential events.

9. Return LCM under Warranty

No warranty can be granted if the precautions stated above have been disregarded. The typical examples of violations are:

- Broken LCD glass
- PCB eyelet's damaged or modified
- PCB conductors damaged
- Circuit modified in any way, including addition of components.
- PCB tampered with by grinding, engraving or painting varnish.
- Soldering to, or modifying the bezel in any manner.

Module repairs will be invoiced to customer upon mutual agreement. Modules must be returned with sufficient description of failure or defects. Any connectors or cable installed by customer must be removed completely without damaging the PCB eyelet's, conductors and terminals.